



Servo Drives and Motors

Technical Data

High performance AC brushless
servo motors and servo drives



Control Techniques™
Leroy-Somer™

Complete servo solutions for continuous and pulse duty applications

Control Techniques and Leroy-Somer offer a full range of servo drive and motor solutions that are tailored to work together to deliver maximum performance for both continuous and pulse duty servo applications.

Pulse duty

The Digitax ST servo drive and the Unimotor hd servo motor make up a complete servo solution for pulse duty applications where high peak torque is required.

Combining low torque with high current overload, the Digitax ST - Unimotor hd solution delivers high performance with superior motor control, reduced cabinet size through compact yet powerful design and flexibility via a range of options.

The pulse duty servo solution offers the highest performance for the most demanding applications such as flying shear, pick and place and industrial robotics.

Continuous duty

The Unidrive M700 servo drive and Unimotor fm servo motor solution is the ideal option for continuous duty applications where continuous torque is required.

The Unidrive M700-Unimotor fm solution brings optimized system performance through an onboard Advanced Motion Controller, maximized throughput with superior motor control, and ultimate flexibility through the option to add significant inertia to the motor.

The continuous duty servo solution delivers high performance for all continuous duty applications such as theatre hoists, printing machines and material handling.

As well as servo control, the Unidrive M700 offers class leading induction motor performance.

Wide range of complementary products

To complete the servo solution, Control Techniques and Leroy-Somer can supply a variety of geared Dynabloc servo motors and a wide range of optional drive modules, and additional equipment such as brakes, encoders and cables.

Contents

	Page.		Page.
1 Introduction to Unimotor fm	4	4 Performance graphs	56
1.1 Overview	4	4.1 Unimotor fm	59
1.2 Ordering information	6	4.2 Unimotor hd	64
1.3 Ratings	8	5 Unidrive M700 and Digitax ST	68
1.4 Peak torque information	12	5.1 Unidrive M700 – continuous duty	68
1.5 Dimensions	13	5.2 Servo drives: Digitax ST – pulse duty	69
2 Introduction to Unimotor hd	20	5.3 Drive and motor combinations	70
2.1 Overview	20	6 Motor and signal cables	102
2.2 Unimotor hd ordering code information	22	6.1 General Cable Specifications	102
2.3 Dimensions and ratings	24	6.2 Power Cables (PUR & PVC)	103
3 Generic information	30	6.3 Signal Cables (PUR & PVC)	104
3.1 Performance definitions	30	6.4 Motor connector details	106
3.2 Motor derating	31	7 General	107
3.3 Nameplate	32		
3.4 Motor selection	33		
3.5 Checklist of operating details	33		
3.6 Points to consider	34		
3.7 Special motor requests	34		
3.8 Calculating load torque	35		
3.9 Understanding motor heating effects	36		
3.10 Feedback selection	38		
3.11 Feedback terminology	39		
3.12 Brake specification	41		
3.13 Radial load	42		
3.14 Bearing life and output shaft strength	49		



1 Introduction to Unimotor fm - continuous duty

1.1 Overview

Unimotor fm is a high performance brushless AC servo motor range designed for use in demanding continuous duty applications. The motors are available in six frame sizes with various mounting arrangements and motor lengths.

1.1.1 Reliability and innovation

Unimotor fm is designed using a proven development process that prioritises innovation and reliability. This process has resulted in a market leading reputation for both performance and quality.

1.1.2 Matched motor and drive combinations

Drives and motors from Control Techniques and Leroy-Somer are designed to function as an optimized system. Unimotor fm is the perfect partner for Unidrive M and Digitax ST.

1.1.3 Features

Unimotor fm is suitable for a wide range of industrial applications, due to its extensive range of features

- Torque range: from 1.4 Nm to 136 Nm
 - High energy parking brakes
 - Numerous connector variants, e.g. vertical, 90 ° low profile, 90 ° rotatable and hybrid box on frame size 250
 - Variety of flange possibilities (IEC/NEMA)
 - Various shaft diameters; keyed or plain
 - IP65 conformance; sealed against water spray and dust when mounted and connected
 - Low inertia for high dynamic performance; high inertia option available
 - World class performance
 - Supported by rigorous testing for performance and reliability
 - Winding voltages for inverter supply of 400 V and 220 V
 - Rated speeds from 1,000 to 6,000 rpm and others available
 - Thermal protection by PTC thermistor/ optional KTY84.130 sensor
 - 48 VDC voltage and lower speeds on request
-

1.1.4 Faster set-up, optimized performance

When a Control Techniques servo drive is connected to a Unimotor fm fitted with a SinCos or Absolute encoder, it can recognize and communicate with the motor to obtain the “electronic nameplate” data. This motor data can then be used to automatically optimize the drive settings. This feature simplifies

commissioning and maintenance, ensures consistent performance and saves time.

1.1.5 Accuracy and resolution to suit your application requirements

Choosing the right feedback device for your application is critical in getting optimum performance. Unimotor fm has a range of feedback options that offer different levels of accuracy and resolution to suit most applications:

- Resolver: robust for extreme applications and conditions - low accuracy, medium resolution
 - Incremental encoder: high accuracy, medium resolution
 - Inductive/capacitive SinCos/Absolute: medium accuracy, high resolution
 - Optical/SinCos/Absolute: high accuracy, high resolution
 - Single turn and multi-turn: Hiperface and EnDAT protocols supported
-

1.1.6 Ideal for retrofit

Unimotor fm is an ideal retrofit choice with features to ensure it can integrate easily with your existing servo motor applications. Unimotor fm has been designed so that existing Unimotor customers can easily migrate to the new platform. All connector interface types and mounting dimensions remain the same. If you are planning to retrofit your system, Unimotor fm is the obvious choice.

1.1.7 Custom built motors

As part of our commitment to you, we can design special products to meet your application specific requirements.

Custom built motors are identified by the code S*** added to the end of the part number and can include custom shafts, connections or coatings.

e.g. SPZ – Motor is left unpainted
SON – Motor is fully painted.

(* Indicates additional letters)

1.1.8 Wide range of accessories

Unimotor fm has a wide range of accessories to meet all your system requirements:

- Feedback and power cables for static and dynamic applications
- Fan boxes
- Gearboxes
- Cable connectors



1.1.9 Quick reference table

Frame size	PCD (mm)	Torque and Inertia values															
075	75	1.40		4.70													
		0.78		2.07													
095	100	2.50		9.30													
		1.45		6.0													
115	115	3.9		16.0													
		5.4		14.8													
142	165	6.20		25.0													
		10.2		36.9													
190	215	11.3		77.0													
		31.3		160.8													
250	300	92.0		136													
		275		400													
Stall	(Nm)	0	1.0	3.0	5.0	8.0	10.0	15.0	20.0	30	60	80	100	136.0			
Inertia	(kg.cm ²)	0	0.8	1.5	2.5	6.5	8.0	9.0	20.0	60.0	100	150	300.0	400.0			

Key: ■ = Nm ■ = Inertia

1.1.10 Conformance and standards



RoHS
Compliant



1.2 Unimotor fm ordering code information - D+10 lead time

Use the information below in the illustration to create an order code for a Unimotor fm.

095	U	3	B	30	5	B
-----	---	---	---	----	---	---

Frame size	Motor voltage	Magnet type	Stator length	Rated speed	Brake	Connection type
075	075-142 Frame	075-142 Frame	075 Frame	075-142 Frame	075-142 Frame	Size 1
095	U = 400V	3 = Standard	B/D	30 = 3000 rpm	0 = Not fitted	B = Power and signal 90° rotatable
115			095 Frame		5 = Parking brake	C = Power 90° rotatable and signal vertical
142			B/C/D			V = Power and signal vertical
			115 Frame			Size 1.5
			B/C/D			J = Power and signal 90° rotatable
			142 Frame			N = Power 90° rotatable and signal vertical
			C/D/E			M = Power and signal vertical

Express availability motors,
available in ten days ex works

Unimotor fm ordering code information - Standard lead time

Additional options are available upon request but may require a longer lead time to complete, please check with the Industrial Automation Center.

095	U	3	A	30	5	B
-----	---	---	---	----	---	---

Frame size	Motor voltage	Magnet type	Stator length	Rated speed	Brake	Connection type**
075	075-190 Frame	075-250 Frame	075	075-190 Frame	075-250	Size 1
095	E = 220V	3 = Standard	A/B/C/D	20 = 2000 rpm	0 = No brake	B = Power and signal 90° rotatable
115	U = 400V		095 - 142	40 = 4000 rpm	5 = Parking brake	C = Power 90° rotatable and signal vertical
142	250 Frame		A/B/C/D/E	60 = 6000 rpm*	X = Special	V = Power and signal vertical
190	U = 400V		190	250 Frame		D = Single cable, power & signal combined, 90° rotatable
250		A/B/C/D/E/F/G/H	10 = 1000 rpm		Size 1.5	
		250*	15 = 1500 rpm		J = Power and signal 90° rotatable	
		D/E/F	20 = 2000 rpm *		N = Power 90° rotatable and signal vertical	
		25 = 2500 rpm *		M = Power and signal vertical		
				E = Single cable, power & signal combined, 90° rotatable		
				Hybrid box		
				H = Power hybrid box		
				X = Special		

* 6000rpm only available on certain lengths:

* 250 D and E lengths, winding speed equal and above 2500rpm must use the hybrid box.

* 250 F lengths, winding speed equal and above 2000rpm must use the hybrid box.

- 190 – Lifting eyes will be fitted as standard on all 190 motors. This is to enable easy handling of these motors that are often over 25 kg in weight. If there is an issue with the lifting eyes causing an obstruction when fitting the mating cable then the lifting eyes maybe removed once the motor is installed in the application.
- Hybrid Box Connection – Due to the increased power rating of some of the 190 motors a hybrid box is now being offered. A motor fitted with the Hybrid box will not be UL marked. If a specific motor from the fm range that now has a Hybrid box has previously been purchased with a connector and is working within an application please contact Control Techniques Dynamics to discuss the options available.
- Single cable only available with certain feedback options. Please check before ordering.

A		CA		A		100	190			
Output shaft		Feedback device		Inertia		PCD		Shaft diameter		
075-142 Frame		075-142 Frame		075-142 Frame		075 Frame only				
A = Key		AE = Resolver		A = Standard + PTC		075	Std	14.0	B/C	
F = Key and half key supplied separately		CA = Incremental Encoder		CFS50	B = High + PTC		095 Frame only			
		EC = Inductive EnDat SinCos Multi-turn		EQI 1331			100	Std	19.0	B/D
		FC = Inductive EnDat SinCos Single-turn		ECI 1319			115 Frame only			
		RA = Optical Hiperface SinCos Multi-turn		SRM 50			115	Std	19.0	B/C
							115	Std	24.0	D
							142 Frame only			
							165	Std	24.0	C/D/E

A		CA		A		100	190			
Output shaft		Feedback device		Inertia		PCD		Shaft diameter		
075-250 Frame		Please refer to page 38 for details.		075-190 Frame		075 Frame only				
A = Key		AE = Resolver			A = Standard + PTC	075	Std	11.0	A	
B = Plain		CA = Incremental encoder		CFS50	B = High + PTC	080		14.0	B/C/D	
E = Key with half key fitted		VF = Capacitive Hiperface SinCos Multi-turn		SEL 52	C = Standard + KTY thermistor	085		19.0	Max	
F = Key and half key supplied separately		WF = Capacitive Hiperface SinCos Single-turn		SEK 52	D = High + KTY thermistor			XXX =	Special	
		EC = Inductive EnDat SinCos Multi-turn		EQI 1331	X = Special	095 Frame only				
		FC = Inductive EnDat SinCos Single-turn		ECI 1319	250 Frame		100	Std	14.0	A
		RA = Optical Hiperface SinCos Multi-turn		SRM 50	A = Standard + PTC			19.0	B/C/D/E	
		SA = Optical Hiperface SinCos Single-turn		SRS 50	C = Standard + KTY thermistor	115		22.0	Max	
		EB = Optical EnDat SinCos Multi-turn		EQN 1325	D = High + KTY thermistor			XXX =	Special	
		FB = Optical EnDat SinCos Single-turn		ECN 1313	X = Special	115 Frame only				
		GB = Optical EnDat only Multi-turn		EQN 1337			115	Std	19.0	A/B/C
		HB = Optical EnDat only Single-turn		ECN 1325			130		24.0	D/E
		NA = Sensorless							24.0	Max
		XX = Specials							XXX =	Special
							142 Frame only			
							165	Std	24.0	A/B/C/D/E
							149		32.0	Max
									XXX =	Special
							190 Frame only			
							215	Std	32.0	A/B/C/D/E/ F/G/H
									42.0	Max
									XXX =	Special
							250 Frame only			
							300	Std	48.0	D/E/F

** Not all options are available on all frames sizes please check before ordering

- Shaft sizing - Please ensure that the correct shaft size is selected to meet the application requirement.
- 142 Connector Rating - Due to the increased power rating of some of the 142 motors a type "J" or "M" Size 1.5 power connector is now being offered. If a specific motor from the fm range that now has a "J" or "M" type connector has previously been purchased with a "B" or "C" or "V" size 1 connector and is working within an application please contact Control Techniques Dynamics to discuss the options available.
- Sensorless mode - Motor performance will be limited at low speed, please read Feedback Terminology section for details.

1.3 Ratings

1.3.1 3 Phase VPWM drives 200-240 Vrms

Δt= 100 °C winding 40 °C maximum ambient. All data subject to ±10 % tolerance

Motor Frame Size (mm)	075E3				095E3					115E3				
Frame length	A	B	C	D	A	B	C	D	E	A	B	C	D	E
Continuous stall torque (Nm)	1.4	2.7	3.7	4.7	2.5	4.5	6.3	7.9	9.3	3.9	7.4	10.8	13.7	16.0
Peak torque (Nm)	4.3	8.0	11.2	14.0	7.4	13.5	18.9	23.7	27.8	11.7	22.2	32.4	41.0	48.0
Standard inertia (kgcm ²)	0.78	1.22	1.64	2.07	1.45	2.60	3.72	4.83	6.0	5.4	7.7	10.0	12.5	14.8
High inertia (kgcm ²)	1.18	1.61	2.03	2.46	3.33	4.5	5.6	6.7	7.8	10.0	12.3	14.7	17.1	19.4
Winding thermal time constant (sec)	63	58	73	78	84	82	90	108	112	103	109	116	127	141
Motor weight unbraked (kg)	2.88	3.68	4.48	5.28	4.49	5.75	7.01	8.27	9.53	6.88	8.68	10.48	12.28	14.08
Motor weight braked (kg)	3.38	4.18	4.98	5.78	5.49	6.75	8.01	9.27	10.53	8.38	10.18	11.98	13.78	15.58
Number of poles	6	6	6	6	6	6	6	6	6	6	6	6	6	6
Speed 2,000 (rpm)														
Kt (Nm/A) =	Kt (Nm/A) = 1.4													
Ke (V/krpm) =	Ke (V/krpm) = 85.5													
Rated torque (Nm)	1.3	2.5	3.5	4.5	2.4	4.3	5.9	7.3	8.5	3.7	7.3	10.1	11.9	14.1
Stall current (A)	1.0	1.9	2.7	3.3	1.8	3.2	4.5	5.6	6.6	2.8	5.3	7.7	9.8	11.4
Rated power(kW)	0.27	0.52	0.73	0.93	0.51	0.90	1.23	1.53	1.77	0.77	1.53	2.12	2.49	2.95
R (ph-ph) (Ohms)	48.24	16.32	8.96	6.22	20.69	6.78	3.79	2.42	1.92	10.65	3.43	1.82	1.81	1.34
L (ph-ph) (mH)	87.47	39.77	24.68	19.15	57.78	26.1	16.36	11.83	9.75	55.83	19.43	12.31	9.5	7.68
RECOMMENDED POWER CONN' SIZE	1	1	1	1	1	1	1	1	1	1	1	1	1	1
Speed 3,000 (rpm)														
Kt (Nm/A) =	Kt (Nm/A) = 0.93													
Ke (V/krpm) =	Ke (V/krpm) = 57													
Rated torque (Nm)	1.3	2.3	3.3	4.2	2.33	4.1	5.6	6.9	8.15	3.5	6.7	9.5	11.2	12.7
Stall current (A)	1.55	2.85	4.00	5.02	2.63	4.84	6.77	8.49	9.95	4.19	7.96	11.61	14.68	17.20
Rated power(kW)	0.41	0.72	1.04	1.31	0.73	1.29	1.76	2.17	2.56	1.10	2.10	2.98	3.52	3.99
R (ph-ph) (Ohms)	19.8	6.69	3.71	2.72	9.62	2.99	1.64	1.07	0.86	4.91	1.52	0.81	0.57	0.43
L (ph-ph) (mH)	37.2	16.8	10.69	8.27	26.29	11.47	7.15	5.16	4.35	20.26	8.63	5.47	4.35	3.41
RECOMMENDED POWER CONN' SIZE	1	1	1	1	1	1	1	1	1	1	1	1	1	HYBRID BOX
Speed 4,000 (rpm)														
Kt (Nm/A) =	Kt (Nm/A) = 0.7													
Ke (V/krpm) =	Ke (V/krpm) = 42.75													
Rated torque (Nm)	1.2	2.1	2.8	3.8	2.3	3.8	5.3	6.4	7.4	3.0	5.8	7.5	8.3	8.8
Stall current (A)	2.06	3.79	5.31	6.67	3.50	6.43	9.00	11.29	13.21	5.57	10.57	15.43	19.50	22.86
Rated power(kW)	0.50	0.86	1.17	1.59	0.94	1.59	2.20	2.68	3.10	1.26	2.43	3.12	3.46	3.69
R (ph-ph) (Ohms)	12.44	4.01	2.26	1.53	5.26	1.76	1.04	0.74	0.48	3.05	0.93	0.49	0.3	0.27
L (ph-ph) (mH)	23.35	9.62	6.32	4.63	14.94	6.67	4.52	3.53	2.44	12.44	5.13	3.34	2.25	2.18
RECOMMENDED POWER CONN' SIZE	1	1	1	1	1	1	1	1	1	1	1	1	1	HYBRID BOX
Speed 6,000 (rpm)														
Kt (Nm/A) =	Kt (Nm/A) = 0.47													
Ke (V/krpm) =	Ke (V/krpm) = 28.5													
Rated torque (Nm)	1.1	1.9	2.8	3.4	1.98	3.2	4.2	N/A	N/A	2.7	5	N/A	N/A	N/A
Stall current (A)	3.06	5.64	7.91	9.94	5.21	9.57	13.40			8.30	15.74			
Rated power(kW)	0.68	1.21	1.73	2.14	1.24	2.01	2.64			1.70	3.14			
R (ph-ph) (Ohms)	5.37	1.81	1.02	0.68	2.33	0.73	0.46			1.5	0.41			
L (ph-ph) (mH)	9.8	4.42	2.88	2.06	6.57	2.77	2.07			6.08	2.34			
RECOMMENDED POWER CONN' SIZE	1	1	1	1	1	1	1			1	1			

N/A Not available

The information contained in this specification is for guidance only and does not form part of any contract.

Control Techniques and Leroy-Somer have an ongoing process of development and reserves the right to change the specification without notice.

Stall torque, rated torque and power relate to maximum continuous operation tested in a 20 °C ambient at 12 kHz drive switching frequency

142E3						190E3								Motor frame size (mm)
A	B	C	D	E		A	B	C	D	E	F	G	H	Frame length
6.2	11.0	15.7	20.5	25.0		11.3	22.5	33.5	44.5	54.0	63.0	71.0	77.0	Continuous stall torque (Nm)
18.6	33.0	47.1	61.5	75.0		33.8	67.5	100.5	133.5	162.0	189.0	213.0	231.0	Peak torque (Nm)
10.2	16.9	23.5	30.2	36.9		31.3	49.8	68.3	86.8	105.3	123.8	142.3	160.8	Standard inertia (kg.cm ²)
23.2	29.8	36.5	43.1	49.8		69.8	88.3	106.8	125.3	143.8	162.3	180.8	199.3	High inertia (kg.cm ²)
145	148	188	206	249		194	214	215	216	251	285	425	564	Winding thermal time constant (sec)
8.81	11.66	14.51	17.36	20.21		12.62	18.08	23.54	28.99	34.44	39.90	45.35	50.81	Motor weight unbraked (kg)
10.91	13.76	16.61	19.46	22.31		16.05	21.50	26.96	32.41	38.09	43.54	49.00	54.45	Motor weight braked (kg)
6	6	6	6	6		8	8	8	8	8	8	8	8	Number of poles
Speed 2,000 (rpm)														
Kt (Nm/A) = 1.4														Kt (Nm/A) =
Ke (V/krpm) = 85.5														Ke (V/krpm) =
5.9	10.4	14.7	18.5	21.5		10.8	20.6	29.4	37.9	44.3	50.5	54.0	56.0	Rated torque (Nm)
4.4	7.9	11.2	14.6	17.9		8.0	16.1	23.9	31.8	38.6	45.0	50.7	55.0	Stall current (A)
1.23	2.18	3.08	3.87	4.49		2.26	4.31	6.15	7.94	9.28	10.58	11.31	11.73	Rated power (kW)
5.56	1.54	0.8	0.51	0.4		1.81	0.50	0.25	0.19	0.13	0.10	0.08	0.05	R (ph-ph) (Ohms)
35.43	14.25	8.99	6.35	5.25		17.34	7.77	4.66	3.26	3.02	2.65	2.13	1.55	L (ph-ph) (mH)
1	1	1	1	1.5		1.5	1.5	1.5	1.5	1.5	HYBRID BOX			Recommended connector size
Speed 3,000 (rpm)														
Kt (Nm/A) = 0.93														Kt (Nm/A) =
Ke (V/krpm) = 57														Ke (V/krpm) =
5.5	9.5	12.8	16.0	18.15		10.3	19.4	26.5	33.2	34.2	35.2	36.2	37.0	Rated torque (Nm)
6.67	11.83	16.88	22.04	26.88		12.10	24.19	36.02	47.85	58.06	67.74	76.34	82.80	Stall current (A)
1.73	2.98	4.02	5.03	5.70		3.24	6.09	8.33	10.43	10.74	11.06	11.37	11.62	Rated power (kW)
2.25	0.68	0.35	0.23	0.16		0.83	0.26	0.13	0.09	0.07	0.05	0.05	0.03	R (ph-ph) (Ohms)
14.68	6.33	3.89	3.66	2.23		7.94	3.87	2.46	1.81	1.55	1.17	1.36	0.88	L (ph-ph) (mH)
1	1	1	1.5	1.5		1.5	1.5	1.5	HYBRID BOX					Recommended connector size
Speed 4,000 (rpm)														
Kt (Nm/A) = 0.7														Kt (Nm/A) =
Ke (V/krpm) = 42.75														Ke (V/krpm) =
4.1	8.1	10.2	12.2	14.0		8.2	18.2	23.0	29.0	N/A	N/A	N/A	N/A	Rated torque (Nm)
8.86	15.71	22.43	29.29	35.71		16.07	32.14	47.86	63.57					Stall current (A)
1.72	3.37	4.27	5.11	5.86		3.43	7.62	9.63	12.15					Rated power (kW)
1.29	0.38	0.23	0.13	0.09		0.46	0.14	0.07	0.06					R (ph-ph) (Ohms)
8.39	3.44	2.49	1.99	1.20		4.34	2.18	1.39	1.26					L (ph-ph) (mH)
1	1	1.5	1.5	1.5		1.5	1.5	HYBRID BOX					Recommended connector size	
Speed 6,000 (rpm)														
Kt (Nm/A) = 0.47														Kt (Nm/A) =
Ke (V/krpm) = 28.5														Ke (V/krpm) =
3.2	N/A	N/A	N/A	N/A		N/A	N/A	N/A	N/A	N/A	N/A	N/A	N/A	Rated torque (Nm)
13.19														Stall current (A)
2.01														Rated power (kW)
0.56														R (ph-ph) (Ohms)
3.67														L (ph-ph) (mH)
1														Recommended connector size

All other figures relate to a 20 °C motor temperature.
Maximum intermittent winding temperature is 140 °C

The recommended connector has been selected using the connector manufacturer's de-rating values applied to a motor at full operational temperature.

1.3.2.3 Phase VPWM drives 380-480 Vrms

Δt = 100 °C winding 40 °C maximum ambient. All data subject to ±10 % tolerance

Motor Frame Size (mm)	75U3				95U3					115U3				
Frame length	A	B	C	D	A	B	C	D	E	A	B	C	D	E
Continuous stall torque (Nm)	1.4	2.7	3.7	4.7	2.5	4.5	6.3	7.9	9.3	3.9	7.4	10.8	13.7	16.0
Peak torque (Nm)	4.3	8.0	11.2	14.0	7.4	13.5	18.9	23.7	27.8	11.7	22.2	32.4	41.0	48.0
Standard inertia (kgcm ²)	0.78	1.22	1.64	2.07	1.45	2.60	3.72	4.83	6.0	5.4	7.7	10.0	12.5	14.8
High inertia (kgcm ²)	1.18	1.61	2.03	2.46	3.33	4.5	5.6	6.7	7.8	10.0	12.3	14.7	17.1	19.4
Winding thermal time constant (sec)	63	58	73	78	84	82	90	108	112	103	109	116	127	141
Motor weight unbraked (kg)	2.88	3.68	4.48	5.28	4.49	5.75	7.01	8.27	9.53	6.88	8.68	10.48	12.28	14.08
Motor weight braked (kg)	3.38	4.18	4.98	5.78	5.49	6.75	8.01	9.27	10.53	8.38	10.18	11.98	13.78	15.58
Number of poles	6	6	6	6	6	6	6	6	6	6	6	6	6	6
Speed 2,000 (rpm)														
Kt (Nm/A) =	Kt (Nm/A) = 2.4													
Ke (V/krpm) =	Ke (V/krpm) = 147													
Rated torque (Nm)	1.3	2.5	3.5	4.5	2.4	4.3	5.9	7.3	8.5	3.7	7.3	10.1	11.9	14.1
Stall current (A)	0.6	1.1	1.6	1.9	1.0	1.9	2.6	3.3	3.9	1.6	3.1	4.5	5.7	6.7
Rated power(kW)	0.27	0.52	0.73	0.93	0.51	0.90	1.23	1.53	1.77	0.77	1.53	2.12	2.49	2.95
R (ph-ph) (Ohms)	148.50	52.20	27.30	19.97	64.08	20.88	10.46	7.46	5.09	32.92	10.68	5.25	3.70	2.75
L (ph-ph) (mH)	258.36	117.28	74.20	56.97	173.40	78.16	47.02	35.44	27.18	139.43	59.51	35.90	27.63	21.87
RECOMMENDED POWER CONN' SIZE	1	1	1	1	1	1	1	1	1	1	1	1	1	1
Speed 3,000 (rpm)														
Kt (Nm/A) =	Kt (Nm/A) = 1.6													
Ke (V/krpm) =	Ke (V/krpm) = 98													
Rated torque (Nm)	1.3	2.3	3.3	4.2	2.3	4.1	5.6	6.9	8.2	3.5	6.7	9.5	11.2	12.7
Stall current (A)	0.9	1.7	2.3	2.9	1.5	2.8	3.9	4.9	5.8	2.4	4.6	6.8	8.5	10.0
Rated power(kW)	0.41	0.72	1.04	1.31	0.73	1.29	1.76	2.17	2.56	1.10	2.10	2.98	3.52	3.99
R (ph-ph) (Ohms)	62.08	21.07	12.54	7.81	26.70	8.63	4.67	3.16	2.27	14.74	4.37	2.30	1.53	1.23
L (ph-ph) (mH)	114.59	52.65	34.18	23.89	76.65	33.71	21.09	15.95	12.06	57.29	25.19	15.57	11.60	9.89
RECOMMENDED POWER CONN' SIZE	1	1	1	1	1	1	1	1	1	1	1	1	1	1
Speed 4,000 (rpm)														
Kt (Nm/A) =	Kt (Nm/A) = 1.2													
Ke (V/krpm) =	Ke (V/krpm) = 73.5													
Rated torque (Nm)	1.2	2.1	2.8	3.8	2.3	3.8	5.3	6.4	7.4	3.0	5.8	7.5	8.3	8.8
Stall current (A)	1.2	2.2	3.1	3.9	2.0	3.8	5.3	6.6	7.7	3.3	6.2	9.0	11.4	13.3
Rated power(kW)	0.50	0.86	1.17	1.59	0.94	1.59	2.20	2.68	3.10	1.26	2.43	3.12	3.46	3.69
R (ph-ph) (Ohms)	38.01	12.71	6.49	4.94	16.14	5.22	2.61	1.81	1.40	8.49	2.61	1.31	0.84	0.66
L (ph-ph) (mH)	68.39	30.46	18.28	13.97	44.25	19.54	11.75	8.86	7.25	33.79	14.87	8.98	6.27	5.35
RECOMMENDED POWER CONN' SIZE	1	1	1	1	1	1	1	1	1	1	1	1	1	1
Speed 6,000 (rpm)														
Kt (Nm/A) =	Kt (Nm/A) = 0.8													
Ke (V/krpm) =	Ke (V/krpm) = 49													
Rated torque (Nm)	1.1	1.9	2.8	3.4	2.0	3.2	4.2	N/A	N/A	2.7	5.0	N/A	N/A	N/A
Stall current (A)	1.8	3.3	4.7	5.8	3.1	5.6	7.9			4.9	9.3			
Rated power(kW)	0.68	1.21	1.73	2.14	1.24	2.01	2.64			1.70	3.14			
R (ph-ph) (Ohms)	15.48	5.19	2.86	2.12	6.59	2.13	1.22			3.48	1.09			
L (ph-ph) (mH)	28.66	12.77	8.01	6.33	18.62	8.24	5.44			14.31	6.30			
RECOMMENDED POWER CONN' SIZE	1	1	1	1	1	1	1			1	1			

N/A Not available

The information contained in this specification is for guidance only and does not form part of any contract.

Control Techniques and Leroy-Somer have an ongoing process of development and reserve the right to change the specification without notice.

Stall torque, rated torque and power relate to maximum continuous operation tested in a 20 °C ambient at 12 kHz drive switching frequency

All other figures relate to a 20 °C motor temperature. Maximum intermittent winding temperature is 140 °C

142U3						190U3								250U3		
A	B	C	D	E		A	B	C	D	E	F	G	H	D	E	F
6.2	11.0	15.7	20.5	25.0		11.3	22.5	33.5	44.5	54.0	63.0	71.0	77.0	92	116	136
18.6	33.0	47.1	61.5	75.0		33.8	67.5	100.5	133.5	162.0	189.0	213.0	231.0	276	348	408
10.2	16.9	23.5	30.2	36.9		31.3	49.8	68.3	86.8	105.3	123.8	142.3	160.8	275	337	400
23.2	29.8	36.5	43.1	49.8		69.8	88.3	106.8	125.3	143.8	162.3	180.8	199.3	408	502	597
145	148	188	206	249		194	214	215	216	251	285	425	564	439	486	608
8.81	11.66	14.51	17.36	20.21		12.62	18.08	23.54	28.99	34.44	39.90	45.35	50.81	57.5	65.5	73.7
10.91	13.76	16.61	19.46	22.31		16.05	21.50	26.96	32.41	38.09	43.54	49.00	54.45	68.5	76.5	84.5
6	6	6	6	6		8	8	8	8	8	8	8	8	10	10	10
														Speed 1,000 (rpm)		
Kt (Nm/A) = 2.4														Kt (Nm/A) = 5.4		
Ke (V/krpm) = 147														Ke (V/krpm) = 323		
5.9	10.4	14.7	18.5	21.5		10.8	20.6	29.4	37.9	44.3	50.5	54.0	56.0	75	92	106
2.6	4.6	6.5	8.5	10.4		4.7	9.4	14.0	18.5	22.5	26.3	29.6	32.1	17.2	21.7	25.4
1.23	2.18	3.08	3.87	4.49		2.26	4.31	6.15	7.94	9.28	10.58	11.31	11.73	7.9	9.6	11.1
14.64	4.71	2.38	1.60	1.11		6.15	1.54	0.83	0.50	0.37	0.28	0.26	0.23	0.61	0.48	0.34
98.76	42.15	26.32	19.46	15.08		52.90	23.55	15.00	8.81	8.68	7.36	6.89	6.30	22.90	19.10	14.90
1	1	1	1	1		1.5	1.5	1.5	1.5	1.5	1.5	1.5	1.5	1.5	1.5	1.5
														Speed 1,500 (rpm)		
Kt (Nm/A) = 1.6														Kt (Nm/A) = 3.6		
Ke (V/krpm) = 98														Ke (V/krpm) = 216		
5.5	9.5	12.8	16.0	18.2		10.3	19.4	26.5	33.2	34.2	35.2	36.2	37.0	67	76	84
3.9	6.9	9.8	12.8	15.6		7.0	14.1	20.9	27.8	33.8	39.4	44.4	48.1	25.8	32.5	38.1
1.73	2.98	4.02	5.03	5.70		3.24	6.09	8.33	10.43	10.74	11.06	11.37	11.62	10.5	11.9	13.2
6.20	2.12	1.08	0.70	0.50		2.73	0.70	0.41	0.22	0.17	0.14	0.15	0.08	0.27	0.21	0.15
42.97	19.11	12.06	8.91	6.70		23.50	10.47	7.35	4.89	3.86	3.60	3.06	2.42	10.00	8.60	6.60
1	1	1	1	1		1.5	1.5	1.5	1.5	1.5	1.5	HYBRID BOX		1.5	1.5	1.5
														Speed 2,000 (rpm)		
Kt (Nm/A) = 1.2														Kt (Nm/A) = 2.7		
Ke (V/krpm) = 73.5														Ke (V/krpm) = 162		
4.1	8.1	10.2	12.2	14.0		8.2	18.2	23.0	29.0	N/A	N/A	N/A	N/A	65	73	81
5.2	9.2	13.1	17.1	20.8		9.4	18.8	27.9	37.1					34.4	43.4	50.9
1.72	3.37	4.27	5.11	5.86		3.43	7.62	9.63	12.15					10.2	11.5	12.7
3.64	1.18	0.61	0.41	0.29		1.35	0.38	0.21	0.14					0.15	0.1	0.08
24.44	10.54	6.78	5.06	3.97		13.56	6.05	3.86	2.45					5.7	4.2	3.7
1	1	1	1.5	1.5		1.5	1.5	1.5	1.5					1.5	Hybrid box	Hybrid box
														Speed 2,500 (rpm)		
Kt (Nm/A) = 0.8														Kt (Nm/A) = 2.1		
Ke (V/krpm) = 49														Ke (V/krpm) = 129		
3.2	5.2	N/A	N/A	N/A		N/A	N/A	N/A	N/A	N/A	N/A	N/A	N/A	62	70	77
7.8	13.8													43.0	54.2	63.6
2.01	3.27													9.7	11	12.1
1.63	0.53													0.09	0.08	0.06
11.08	4.78													3.5	3.1	2.6
1	1													Hybrid box	Hybrid box	Hybrid box

The recommended connector has been selected using the connector manufacturer's de-rating values applied to a motor at full operating temperature.

The Unimotor fm 250 servo motor has been designed to give greatest motor efficiency up to a rated, or rms, speed of 1,500 rpm. The range does include the optional speeds of 2,000 rpm and 2,500 rpm. These windings will allow the end user to enter the intermittent speed zone as well as the intermittent torque zone on the 250 motor.

These higher speed windings are designed with optimum kt values that allow increased speed without demanding very high currents.

The Unimotor fm 250 is designed for S2 to S6 duties and as such the rms values play an important part in the motor selection for torque and speed.

1.4 Peak torque information

On some of the frame sizes the full peak torque cannot be achieved at the full 100 % rms current level. As shown below the 075 motors is not affected by the reduced levels and remains constant up to 100 % rms current, whereas the 250 motors all show a drop at some point along the % rms current line.

The graph below shows the standard peak factor for each frame size.

Standard peak torque factor

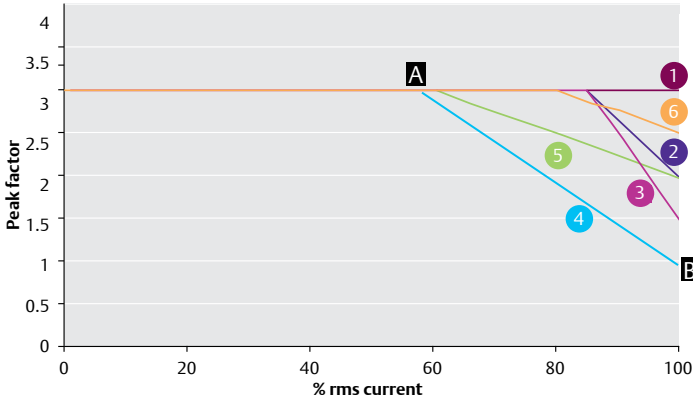

1 — 075 2 — 095 3 — 115 4 — 142 5 — 190 6 — 250

To use this graph correctly the rms current and rms speed of the application have to be calculated. The rms current value must then be converted into a percentage of the full motor current available at that rms speed value. If the full current available is 10 Amps and the rms current is 7.5 Amps, then the percentage rms current value is 75 %. This value can then be plotted onto the graph in order to obtain the peak factor. The peak factor is then used as part of the calculation, shown below, for the peak torque value.

$$\text{Peak factor} \times \text{Stall current} \times \text{kt} = \text{Peak torque}$$

An example would be with a 142U3E300 motor where the % rms current value is calculated to 50 %, the peak factor would be 3 (point A).

$$\text{Peak factor} \times \text{Stall current} \times \text{kt} = \text{Peak torque}$$

$$3.00 \times 15.6 \times 1.6 = 74.9 \text{ Nm}$$

But if the % rms current value were to be calculated at a level of 100 %, the peak factor would equal 1.00 (point B).

$$\text{Peak factor} \times \text{Stall current} \times \text{kt} = \text{Peak torque}$$

$$1.00 \times 15.6 \times 1.6 = 25 \text{ Nm}$$

Peak torque is defined for a maximum period of 250 ms, rms 3,000 rpm $\Delta_{\text{max}} = 100^\circ\text{C}$, 40°C ambient.

Unimotor fm	Peak factor 0 % to 100 % rms	
075	3.0	
095	Peak factor 0 % to 88 % rms	Peak factor @ 100 % rms
	3.0	2.0
115	Peak factor 0 % to 86 % rms	Peak factor @ 100 % rms
	3.0	1.5
142	Peak factor 0 % to 57 % rms	Peak factor @ 100 % rms
	3.0	1.0
190	Peak factor 0 % to 60 % rms	Peak factor @ 100 % rms
	3.0	2.0
250	Peak factor 0 % to 80 % rms	Peak factor @ 100 % rms
	3.0	2.5

1.5 Dimensions

1.5.1 Frame size 075

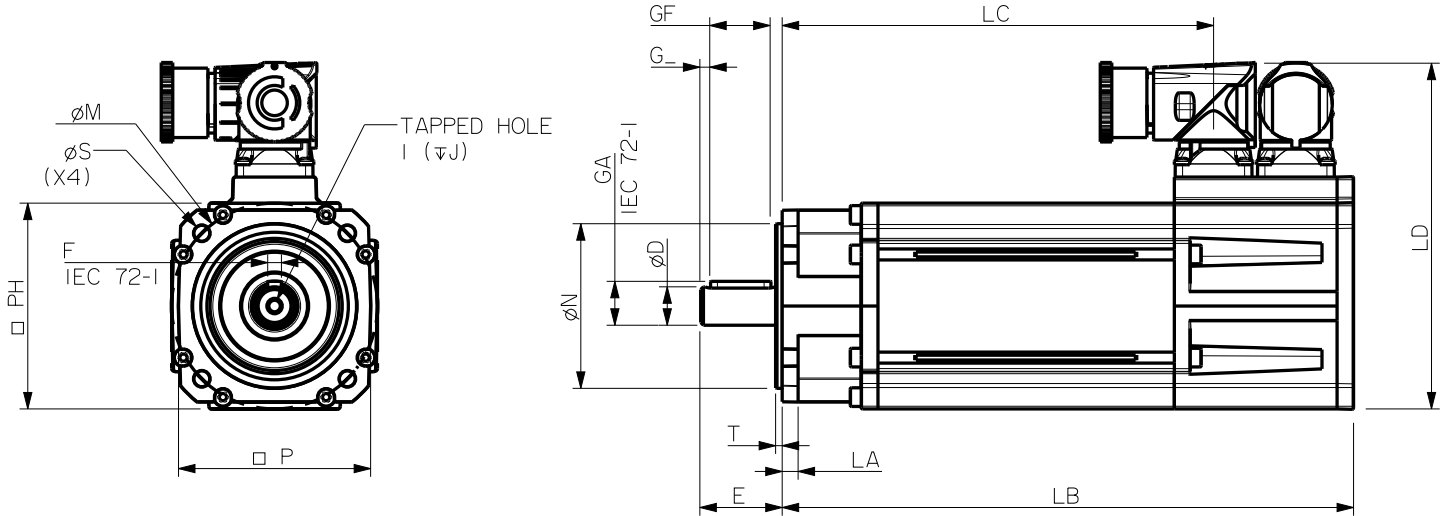

Standard motor dimension (mm) Note all dimensions shown are at nominal

	Unbraked length		Braked length		Flange thickness LA (± 0.5)	Register length T (± 0.1)	Register diameter N (j6)	Overall height (B) LD (± 1)	Flange square P (± 0.4)	Fixing hole diameter S (H14)	Fixing hole PCD M (± 0.4)	Motor housing PH (± 0.5)	Mounting bolts
	LB (± 1)	LC (± 1)	LB (± 1)	LC (± 1)									
075A	208.2	157.2	238.2	187.2	5.8	2.4	60.0	126.0	70.0	5.8	75.0	75	M5
075B	238.2	187.2	268.2	217.2									
075C	268.2	217.2	298.2	247.2									
075D	298.2	247.2	328.2	277.2									

Optional flange motor dimensions (mm)

	Unbraked length		Braked length	
	LB (± 1.0)	LC (± 1.0)	LB (± 1.0)	LC (± 1.0)
075A	192.6	141.6	222.6	171.6
075B	222.6	171.6	252.6	201.6
075C	252.6	201.6	282.6	231.6
075D	282.6	231.6	312.6	261.6

Optional flange dimensions (mm)

PCD code	Front end frame type	Flange square	Fixing hole PCD	Register diameter	Flange thickness	Fixing hole diameter
		P (± 0.4)	M (± 0.4)	N (j6)	LA (± 0.5)	S (H14)
075	Extended	70.0	66.7 - 75.0	60.0	5.8	5.80
080	Extended	70.0	75.0 - 80.0	60.0	5.8	5.80
085	Flat	80.0	85.0	70.0	5.8	7.00

Optional connector height (mm)

Connection type	Overall height
	LD (± 1)
V	118.5
C	126.0

Output shaft dimensions (mm)

	Shaft diameter	Shaft length	Key height	Key length	Key to shaft end	Key width	Tapped hole thread size	Tapped hole depth
	D (j6)	E (± 0.45)	GA	GF (± 0.25)	G (± 1.1)	F	I	J (± 0.4)
075A (Std)	11	23	12.5	14	3.6	4	M4X0.7	11
075B-D (Std)	14	30	16	25	1.5	5	M5X0.8	13.5
075A-D (Opt)	19	40	21.5	32	3.6	6.0	M6X1.0	17.0

NOTE: Shaft options below the standard (Std) dimensions will require customer approval and may not be covered by warranty.

1.5.2 Frame size 095

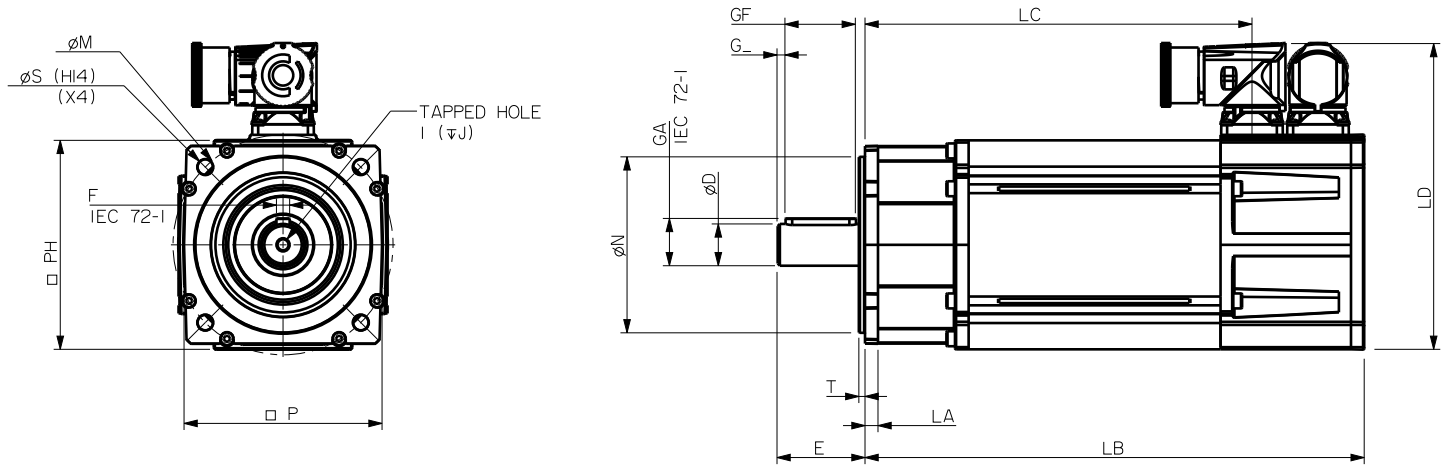

Standard motor dimension (mm) Note all dimensions shown are at nominal

	Unbraked length		Braked length		Flange thickness LA (± 0.5)	Register length T (± 0.1)	Register diameter N (j6)	Overall height (B) LD (± 1)	Flange square P (± 0.4)	Fixing hole diameter S (H14)	Fixing hole PCD M (± 0.4)	Motor housing PH (± 0.6)	Mounting bolts
	LB (± 1)	LC (± 1)	LB (± 1)	LC (± 1)									
095A	226.9	175.9	256.9	205.9	5.9	2.8	80.0	139.0	90.0	7.0	100.0	95.0	M6
095B	256.9	205.9	286.9	235.9									
095C	286.9	235.9	316.9	265.9									
095D	316.9	265.9	346.9	295.9									
095E	346.9	295.9	376.9	325.9									

Optional flat flange motor dimensions (mm)

	Unbraked length		Braked length	
	LB (± 1.0)	LC (± 1.0)	LB (± 1.0)	LC (± 1.0)
	095A	201.8	150.8	231.8
095B	231.8	180.8	261.8	210.8
095C	261.8	210.8	291.8	240.8
095D	291.8	240.8	321.8	270.8
095E	321.8	270.8	351.8	300.8

Optional connector height (mm)

Connection type	Overall height
	LD (± 1)
V	131.5
C	139.0

Optional flange dimensions (mm)

PCD code	Front end frame type	Flange square	Fixing hole PCD	Register diameter	Flange thickness	Fixing hole diameter
		P (± 0.4)	M (± 0.4)	N (j6)	LA (± 0.5)	S (H14)
098	Extended	90.0	98.4	73.0	5.9	7.0
115	Flat	105.0	115.0	95.0	6.8	10.0

Output shaft dimensions (mm)

	Shaft diameter	Shaft length	Key height	Key length	Key to shaft end	Key width	Tapped hole thread size	Tapped hole depth
	D (j6)	E (± 0.45)	GA	GF (± 0.25)	G (± 1.1)	F	I	J (± 0.4)
095A (Std)	14	30	16	25	1.5	5	M5X0.8	13.5
095B-E (Std)	19	40	21.5	32	3.6	6	M6X1.0	17
095A-E (Opt)	22	50	24.5	40	4.6	6	M8X1.25	20

NOTE: Shaft options below the standard (Std) dimensions will require customer approval and may not be covered by warranty.

1.5.3 Frame size 115

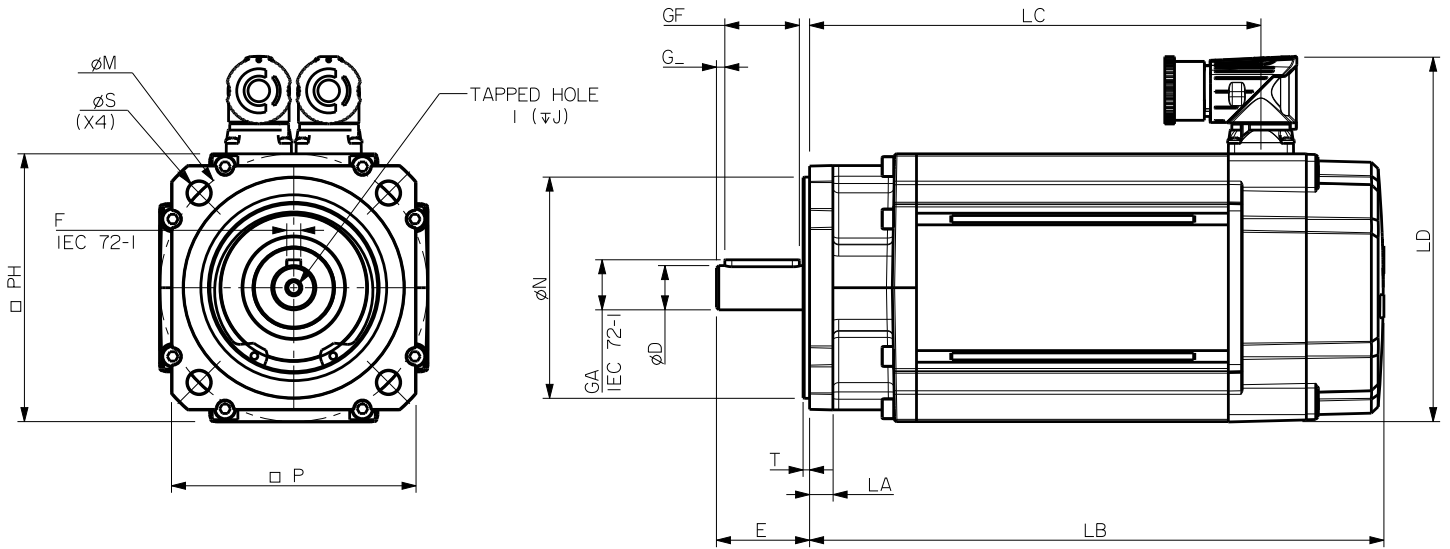

Standard motor dimension (mm) Note all dimensions shown are at nominal

	Unbraked length		Braked length		Flange thickness LA (± 0.5)	Register length T (± 0.1)	Register diameter N (j6)	Overall height (B) LD (± 1)	Flange square P (± 0.4)	Fixing hole diameter S (H14)	Fixing hole PCD M (± 0.4)	Motor housing PH (± 0.6)	Mounting bolts
	LB* (± 1)	LC (± 1)	LB* (± 1)	LC (± 1)									
115A	246.6	193.8	276.6	223.8	10.1	2.8	95	156.5	105	10	115	115	M8
115B	276.6	223.8	306.6	253.8									
115C	306.6	253.8	336.6	283.8									
115D	336.6	283.8	366.6	313.8									
115E	366.6	313.8	396.6	343.8									

Optional flat flange motor dimensions (mm)

	Unbraked length		Braked length	
	LB* (± 1.0)	LC (± 1.0)	LB (± 1.0)	LC (± 1.0)
115A	213.9	161.1	243.9	191.1
115B	243.9	191.1	273.9	221.1
115C	273.9	221.1	303.9	251.1
115D	303.9	251.1	333.9	281.1
115E	333.9	281.1	363.9	311.1

Optional connector height (mm)

Connection type	Overall height
	LD (± 1)
V	149.0
C	156.5

Optional flange dimensions (mm)

PCD code	Front end frame type	Flange square	Fixing hole PCD	Register diameter	Flange thickness	Fixing hole diameter
		P (± 0.4)	M (± 0.4)	N (j6)	LA (± 0.4)	S (H14)
130	Flat	116.0	130.0	110.0	13.2	10.0

Output shaft dimensions (mm)

	Shaft diameter	Shaft length	Key height	Key length	Key to shaft end	Key width	Tapped hole thread size	Tapped hole depth
	D (j6)	E (± 0.45)	GA	GF (± 0.25)	G (± 1.1)	F	I	J (± 0.4)
115A-C (Std)	19.0	40.0	21.5	32.0	3.6	6.0	M6X1.0	17.0
115D-E (Std)	24	50	27	40	4.6	8	M8X1.25	20.0

NOTE: Shaft options below the standard (Std) dimensions will require customer approval and may not be covered by warranty.

*For EC encoders reduce LB length by -13. For AE resolvers reduce LB length by -23

1.5.4 Frame size 142

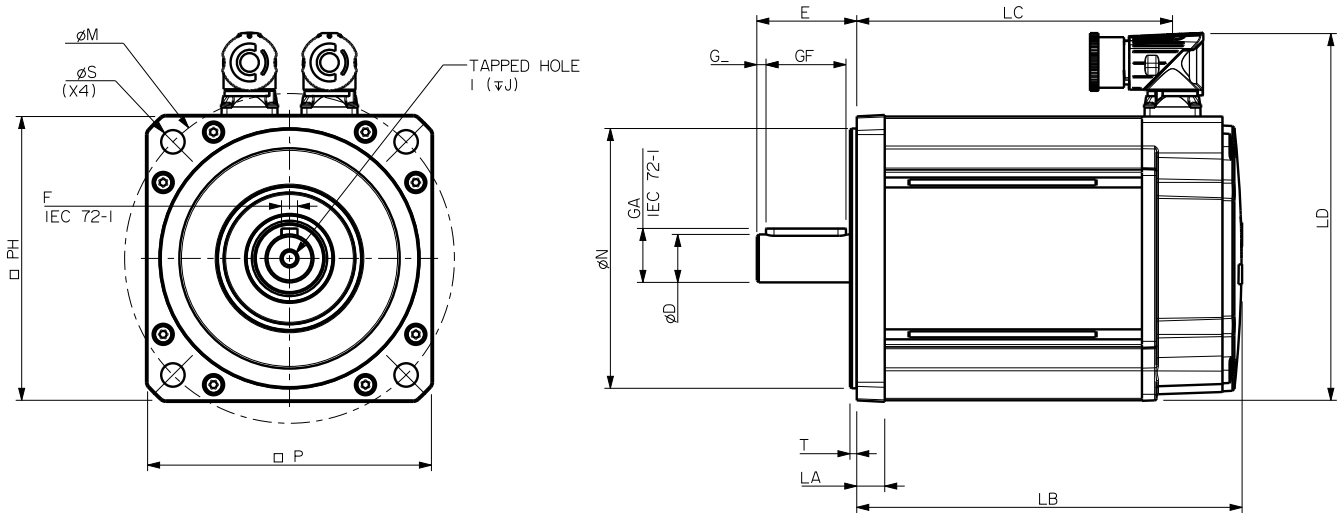

Standard motor dimension (mm) Note all dimensions shown are at nominal

	Unbraked length		Braked length		Flange thickness LA (± 0.1)	Register length T (± 0.1)	Register diameter N (j6)	Overall height (B) LD (± 1)	Flange square P (± 0.4)	Fixing hole diameter S (H14)	Fixing hole PCD M (± 0.4)	Motor housing PH (± 0.7)	Mounting bolts M10
	LB (± 1)	LC (± 1)	LB (± 1)	LC (± 1)									
142A	192.8	158	252.8	218	14	3.4	130	183.5	142	12	165	143	M10
142B	222.8	188	282.8	248									
142C	252.8	218	312.8	278									
142D	282.8	248	342.8	308									
142E	312.8	278	372.8	338									

Optional motor flange dimensions (mm)

	Unbraked length		Braked length	
	LB (± 1.0)	LC (± 1.0)	LB (± 1.0)	LC (± 1.0)
142A	241.8	207	301.8	267
142B	271.8	237	331.8	297
142C	301.8	267	361.8	327
142D	331.8	297	391.8	357
142E	361.8	327	421.8	387

Optional connector height (mm)

Connection type	Overall height
	LD (± 1.0)
V	176.0
C	183.5
J	204.5
M	184.5

Optional flange dimensions (mm)

PCD code	Front end frame type	Flange square	Fixing hole PCD	Register diameter	Flange thickness	Fixing hole diameter
		P (± 0.4)	M (± 0.1)	N (j6)	LA (± 0.5)	S (H14)
149	Extended	140.0	149.2	114.3	11.5	12.0

Output shaft dimensions (mm)

	Shaft diameter	Shaft length	Key height	Key length	Key to shaft end	Key width	Tapped hole thread size	Tapped hole depth
	D (j6)	E (± 0.45)	GA	GF (± 0.25)	G (± 1.1)	F	I	J (± 0.4)
142A-E (Std)	24	50	27	40	4.6	8	M8x1.25	20.0
142 A-E (Opt)	22	50	24.5	40	4.6	6	M8x1.25	20
142 A-E (Opt)	28	60	31	50	4.6	8	M10x1.5	23
142 A-E (Opt)	32	58	35	50	4.6	10	M12x1.75	29

NOTE: Shaft options below the standard (Std) dimensions will require customer approval and may not be covered by warranty.

1.5.5 Frame size 190

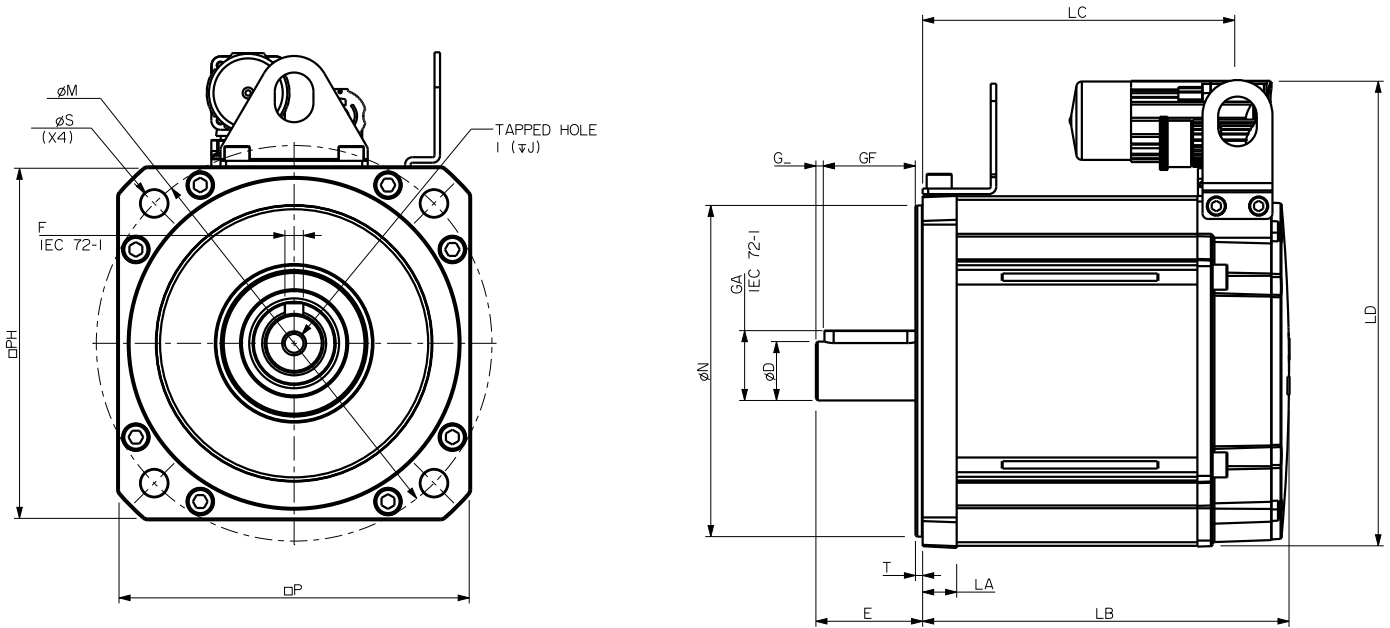

Standard motor dimension (mm) Note all dimensions shown are at nominal

	Unbraked length		Braked length		Flange thickness LA (± 0.1)	Register length T (± 0.1)	Register diameter N (j6)	Overall height (J) LD (± 1)	Flange square P (± 0.4)	Fixing hole diameter S (H14)	Fixing hole PCD M (± 0.4)	Motor housing PH (± 1.5)	Mounting bolts
	LB (± 1)	LC (± 1)	LB (± 1)	LC (± 1)									
190 A	199.4	169.6	289.4	259.6	18.5	3.9	180	252.5	190.3	14.5	215	190	M12
190B	229.4	199.6	319.4	289.6									
190C	259.4	229.6	349.4	319.6									
190D	289.4	259.6	379.4	349.6									
190E	319.4	289.6	409.4	379.6									
190F	349.4	319.6	439.4	409.6									
190G	379.4	349.6	469.4	439.6									
190H	409.4	379.6	499.4	469.6									

Optional connector height (mm)

Connection type	Overall height
	LD (± 1.0)
M	232.0
N	252.5
H (<40 Amp)	287.0
H (<60 Amp)	323.0

Output shaft dimensions (mm)

	Shaft diameter	Shaft length	Key height	Key length	Key to shaft end	Key width	Tapped hole thread size	Tapped hole depth
	D (j6)	E (± 0.45)	GA	GF (± 0.25)	G (± 1.1)	F	I	J (± 0.4)
190 A-H (Std)	32	58	35	50	4.6	10	M12X1.75	29
190 A-H (Opt)	38	58	41	50	4.6	10	M12X1.75	29
190 A-H (Opt)	28	60	31	50	4.6	8	M10x1.5	23
190 A-H (Opt)	42	110	45	100	4.6	12	M16x2.0	37

NOTE: Shaft options below the standard (Std) dimensions will require customer approval and may not be covered by warranty.

1.5.6 Frame size 250

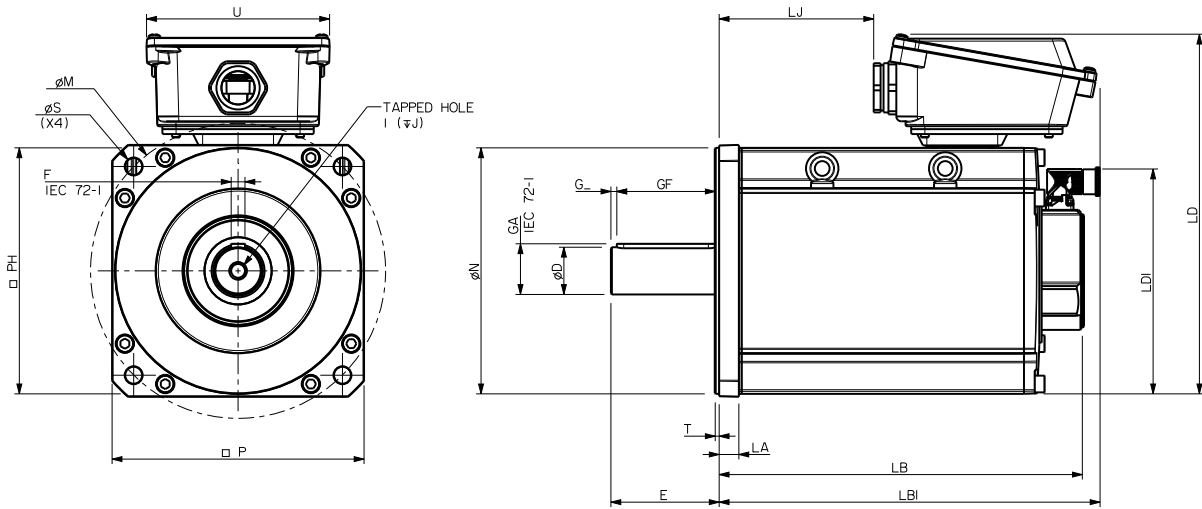

Standard motor dimension (mm) Note all dimensions shown are at nominal

	Motor Length			Flange thickness	Register length	Register diameter	Overall height (H)	Flange square	Fixing hole diameter	Fixing hole PCD	Motor housing	Hybrid box width	Signal connector height	Mounting bolts											
	LB (± 1.3)	LB1 (± 2.0)	LJ (± 1.3)												LA (± 0.1)	T (± 0.1)	N (j6)	LD (± 1.0)	P (± 0.6)	S (H14)	M (± 0.4)	PH (± 1.0)	U (± 0.4)	LD1 (± 1.0)	
Unbraked motor																									
250D	375.7	406.1	179.7	20.0	4.50	250.0	363.5	256.0	18.5	300.0	250.0	186.0	228.5	M16											
250E	405.7	436.1	209.7																						
250F	435.7	466.1	239.7																						
Braked motor																									
250D	447.5	477.9	251.5																						
250E	477.5	507.9	281.5																						
250F	507.5	537.9	311.5																						

For heidenhain feedback devices please add 15mm to LB length.

Output shaft dimensions (mm)

	Shaft diameter	Shaft length	Key height	Key length	Key to shaft end	Key width	Tapped hole thread size	Tapped hole depth
	D (k6)	E (± 0.45)	GA (To IEC 72-1)	GF (± 0.25)	G (± 1.1)	F (h9)	I	J (± 1.0)
38.0 Opt	38.0	80.0	41.0	70.0	4.6	10.0	M12 x 1.75	29.0
42.0 Opt	42.0	110.0	45.0	100.0	6.0	12.0	M16 x 2.0	37.0
48.0 D-F Std	48.0	110.0	51.5	100.0	6.0	14.0	M16 x 2.0	37.0

Optional connector height (mm)

Connection type	Power overall height	Signal overall height
	LD (± 1.0)	LD1 (± 1.0)
M	291.5	221.0
N	312.5	221.0
J	312.5	221.0

NOTE: Shaft options below the standard (Std) dimensions will require customer approval and may not be covered by warranty.



Case Study 1 - Servo technology improves reliability and accuracy of new packaging machine

CMC Machines designs and manufactures advanced systems for the paper and film wrapping industry.

The Challenge

CMC needed an advanced servo system for a new design of packaging machine: Cartonwrap. Cartonwrap machines use a cardboard roll to make boxes of virtually any size, adapting the container to the size of the item. Products are fed into the machine on a conveyor and the box is formed around them. This eliminates the need to stock pre-formed boxes and leads to a drastic reduction of filling materials inside boxes.

The Solution

CMC chose a servo drive solution from Control Techniques and Leroy-Somer: each Cartonwrap machine uses 22 Digitax ST servo drives and Unimotor fm servo motors. Digitax ST drives use multi-network management via a central PC and Ethernet for coordinating all production menus and motion parametric equations on the individual process components. CMC machinery uses SM Applications Plus modules in each drive - providing automation controllers with integrated fieldbus communications and I/O.

The Benefits

- Control Techniques and Leroy-Somer engineers developed bespoke software for CMC's machines
- SM-Applications plus modules eliminate need for external PLC, resulting in increased communication speed due to reduced wiring



2 Introduction to Unimotor hd - pulse duty

2.1 Overview

Unimotor hd is a high dynamic brushless AC servo motor range designed for use in pulse duty applications where rapid acceleration and deceleration are required. The motors are available in six sizes from 055 to 190.

2.1.1 Reliability and innovation

Unimotor hd is designed using a proven development process that prioritizes innovation and reliability. This process has resulted in a market leading reputation for both performance and quality.

2.1.2 Matched motor and drive combinations

Drives and motors from Control Techniques and Leroy-Somer are designed to function as an optimized system. Unimotor hd is the perfect partner for Unidrive M and Digitax ST

2.1.3 Key features

Unimotor hd is suitable for a wide range of industrial applications, due to its extensive features.

- Torque range: 0.72 Nm to 85.0 Nm
- High torque to inertia ratio for high dynamic performance
- Compact but powerful
- High energy dissipation brakes
- IP65 conformance: sealed against water spray and dust when mounted and connected
- Segmented stator design
- World class performance
- Supported by rigorous testing for performance and reliability
- Winding voltages for inverter supply of 400 V and 220 V
- Rated speeds from 1,000 to 6,000 rpm
- Larger shafts to increase torsional rigidity
- Thermal protection by PTC thermistor/ optional KTY84.130 sensor

2.1.4 The ultimate motor and drive combinations

Control Techniques and Leroy-Somer offer drive and motor combinations that provide an optimized system in terms of ratings, performance, cost and ease of use. Unimotor hd motors fitted with high resolution SinCos or Absolute encoders are pre-loaded with the motor “electronic nameplate” data during the manufacturing process. This data can be read by any of our servo drives and used to automatically optimize the drive settings. This feature simplifies commissioning and maintenance, ensures consistent performance and saves time.

2.1.5 Accuracy and resolution to suit your application requirements

Choosing the right feedback device for your application is critical in getting optimum performance. Unimotor hd has a range of feedback options that offer different levels of accuracy and resolution to suit most applications:

- Resolver: robust for extreme applications and conditions - low accuracy, medium resolution
- Incremental encoder: high accuracy, medium resolution
- Inductive/capacitive SinCos/Absolute: medium accuracy, high resolution
- Optical/SinCos/Absolute: high accuracy, high resolution
- Single turn and multi-turn: Hiperface and EnDAT protocols supported

2.1.6 Custom built motors

As part of our commitment to you, we can design special products to meet your application specific requirements.



2.1.7 Quick reference table

Frame size	PCD (mm)																						
055	63			0.72	1.65																		
				0.14	0.36																		
067	75					1.45	3.70																
						0.30	0.75																
089	100							3.20	8.00														
								0.87	2.34														
115	130									5.80	18.80												
										2.42	8.38												
142	165																			25.0	38.0		
																				17.0	27.2		
190	215																					52.0	85.0
																						54.6	103.5
Stall	(Nm)	0	0.5	1.0	3.0	5.0	8.0	10.0	15.0	20.0	30	60	85.0										
Inertia	(kg.cm ²)	0	0.1	0.2	0.7	1.5	2.5	6.5	8.0	9.0	20.0	60.0	103.5										

Key: ■ = Nm ■ = Inertia

2.1.8 Conformance and standards



RoHS
Compliant



2.2 Unimotor hd ordering code Information - D+10 lead time

Use the information below in the illustration to create an order code for a Unimotor HD.

089	UD	B	30	0	B
Frame size	Motor voltage	Stator length	Rated speed	Brake	Connection type
055	ED = 220 V	055	055 Frame	055 Frame	Size 1
067		A/B	30 = 3000 rpm	0 = Not fitted	
089		067	067 Frame	1 = Parking brake	
115		A	30 = 3000 rpm	067-142 Frame	
142		089	089 Frame	0 = Not fitted	
		C	30 = 3000 rpm	5 = Parking brake	
		115	115 Frame		
		B	*20 = 2000 rpm		
		055-142 Frame	055	30 = 3000 rpm	
		UD = 400 V	A/B/C	142 Frame	
	067		30 = 3000 rpm		
	B		* 115UDD20 only		
	089				
	B/C				
	115				
	B/C/D				
	142				
	C				

Express availability motors, available in ten days ex works

Unimotor hd ordering code Information - Standard lead time

Additional options are available upon request but may require a longer lead time to complete, please check with the Industrial Automation Centre

067	UD	B	30	0	B
Frame size	Motor voltage	Stator length	Rated speed*	Brake	Connection type**
055	ED = 220 V	055	055-067 Frame	055 - 190 Frame	Size 1
067	UD = 400 V	A/B/C	30 = 3000 rpm	0 = Not fitted	
089		067	60 = 6000 rpm	5 = Parking brake	D = Single cable, power & signal combined, 90° rotatable
115		A/B/C	089 Frame		
142		089	30 = 3000 rpm		
190		A/B/C	40 = 4000 rpm		
		115	60 = 6000 rpm		
		B/C/D	115 Frame		
		142	20 = 2000 rpm		
		C/D/E	30 = 3000 rpm		
		190	142 Frame		
	C/D/F	10 = 1000 rpm			
		15 = 1500 rpm			
		20 = 2000 rpm			
		30 = 3000 rpm			
		190 Frame			
		10 = 1000 rpm			
	15 = 1500 rpm				
	20 = 2000 rpm				

** Single cable only available with certain feedback options. Please check before ordering.

* Not all speeds are available on all motors.

A		CA			A			
Output shaft		Feedback device			Inertia	PCD	Shaft diameter	
055 Frame		055-067 Frame			055 Frame	055 Frame	055 Frame	
A =	Key	AR =	Resolver		A =	Standard + PTC	063 = Standard	110 = 11 mm
	067-142 Frame	CR =	Incremental Encoder	R35i		067-142 Frame		140 = 14 mm
A =	Key	EM =	Inductive EnDat SinCos Multi-turn	EQI 1130	A =	Standard + PTC		
F =	Key and half key supplied separately	089-142 Frame						
		AE =	Resolver					
		CA =	Incremental Encoder	CFS50				
		EC =	Inductive EnDat SinCos Multi-turn	EQI 1331				
		EB =	Optical EnDat SinCos Multi-turn	EQN 1325				
		RA =	Optical Hiperface SinCos Multi-turn	SRM 50				

A		CA			A			
Output shaft		Feedback device			Inertia	Connection type**	Shaft Diameter	
055 - 190 Frame		055-067 Frame. Please refer to page 38 for details			055-190 Frame	055 Frame	055 Frame	
A =	Key	AR =	Resolver		A =	Standard + PTC	063 = Standard	110 = 11 mm
B =	Plain	CR =	Incremental Encoder	R35i	C =	Standard + KTY thermistor		140 = 14 mm
E =	Key with half key fitted	EM =	Inductive EnDat SinCos Multi-turn	EQI 1130	E =	Standard + PTC + lifting brackets		
F =	Key and half key supplied separately	FM =	Inductive EnDat SinCos Single-turn	ECI 1118				
		TL =	Optical Hiperface SinCos Multi-turn	SKM36				
		UL =	Optical Hiperface SinCos Single-turn	SKS36				
		EG =	Inductive EnDat only Multi-turn	EQI 1131				
		FG =	Inductive EnDat only Single-turn	ECI 1119				
		EN =	Optical EnDat only Multi-turn	EQN 1135				
		FN =	Optical EnDat only Single-turn	ECN 1123				
		XX =	Specials					
		089 - 190 Frame						
		AE =	Resolver					
		CA =	Incremental Encoder	CFS50				
		VF =	Capacitive Hiperface SinCos Multi-turn	SEL 52				
		WF =	Capacitive Hiperface SinCos Single-turn	SEK 52				
		EC =	Inductive EnDat SinCos Multi-turn	EQI 1331				
		FC =	Inductive EnDat SinCos Single-turn	ECI 1319				
		RA =	Optical Hiperface SinCos Multi-turn	SRM 50				
		SA =	Optical Hiperface SinCos Single-turn	SRS 50				
		EB =	Optical EnDat SinCos Multi-turn	EQN 1325				
		FB =	Optical EnDat SinCos Single-turn	ECN 1313				
		GB =	Optical EnDat only Multi-turn	EQN 1337				
		HB =	Optical EnDat only Single-turn	ECN 1325				
		XX =	Specials					

2.3.2 Frame size 067 for 3 phase VPWM drives

Motor frame size (mm)	067ED			067UD		
Voltage (Vrms)	200-240			380-480		
Frame length	A	B	C	A	B	C
Continuous stall torque (Nm)	1.45	2.55	3.70	1.45	2.55	3.70
Peak torque (Nm)	4.35	7.65	11.10	4.35	7.65	11.10
Standard inertia (kgcm ²)	0.30	0.53	0.75	0.30	0.53	0.75
Winding thermal time constant (sec)	54	61	65	54	61	65
Motor weight unbraked (kg)	1.96	2.56	3.16	1.96	2.56	3.16
Motor weight braked (kg)	2.56	3.16	3.76	2.56	3.16	3.76
Number of poles	10	10	10	10	10	10
Speed 3,000 (rpm)	Kt (Nm/A) = 0.93			0.80	1.60	1.60
	Ke (V/krpm) = 57.00			49.00	98.00	98.00
Rated torque (Nm)	1.40	2.45	3.50	1.40	2.45	3.50
Stall current (A)	1.56	2.74	3.98	1.81	1.59	2.31
Rated power(kW)	0.44	0.77	1.10	0.44	0.77	1.10
R (ph-ph) (Ohms)	14.92	4.88	3.33	11.69	15.20	10.70
L (ph-ph) (mH)	45.4	17.4	12.7	35.2	54.2	40.8
Recommended power conn' size	1	1	1	1	1	1
Speed 6,000 (rpm)	Kt (Nm/A) = 0.47			0.8		
	Ke (V/krpm) = 28.50			49.00		
Rated torque (Nm)	1.30	2.20		1.30	2.20	3.10
Stall current (A)	3.09	5.43		1.81	3.19	4.63
Rated power(kW)	0.82	1.38		0.82	1.38	1.95
R (ph-ph) (Ohms)	3.86	1.22		11.69	3.79	2.68
L (ph-ph) (mH)	11.1	4.4		35.2	13.6	10.2
Recommended power conn' size	1	1		1	1	1

$\Delta t = 100^\circ\text{C}$ winding 40°C maximum ambient

All data subject to $\pm 10\%$ tolerance

Stall torque, rated torque and power relate to maximum continuous operation tested in a 20°C ambient at 12 kHz drive switching frequency

All other figures relate to a 20°C motor temperature.

Maximum intermittent winding temperature is 140°C

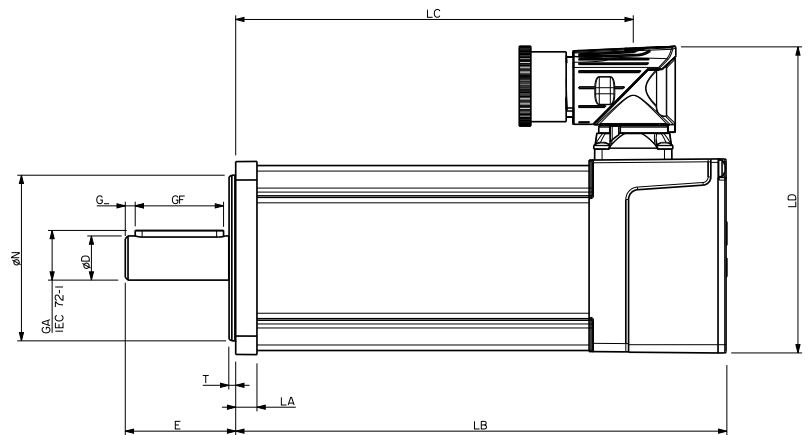
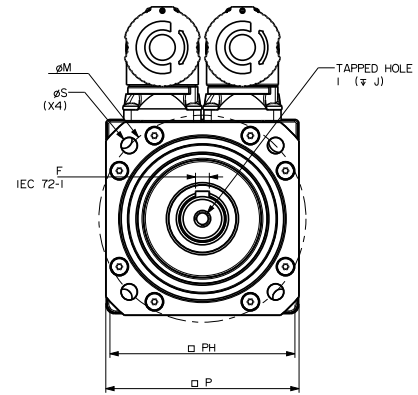

Motor dimension (mm)

	Feedback AR, CR, EM/FM				Flange thickness	Register length	Register diameter	Overall height	Flange square	Fixing hole diameter	Fixing hole PCD	Motor housing	Mounting bolts
	Unbraked length		Braked length										
	LB (± 0.9)	LC (± 1.0)	LB (± 0.9)	LC (± 1.0)									
067A	142.9	109.0	177.9	144.0	7.5	2.50	60.0	111.5	70.0	5.8	75.0	67.00	M5
067B	172.9	139.0	207.9	174.0									
067C	202.9	169.0	237.9	204.0									

	Feedback TL/UL			
	Unbraked length		Braked length	
	LB (± 1.0)	LB (± 1.0)	LB (± 1.0)	LB (± 1.0)
067A	157.7	123.5	192.7	158.5
067B	187.7	153.5	222.7	188.5
067C	217.7	183.5	252.7	218.5

Shaft dimensions (mm)

	Shaft diameter	Shaft length	Key height	Key length	Key to shaft end	Key width	Tapped hole thread size	Tapped hole depth
	D (j6)	E	GA	GF	G	F (h9)	I	J (± 1.0)
14.0 Std	14.0	30.0	16.0	25.0	1.5	5.0	M5 x 0.8	13.5

2.3.4 Frame size 115 for 3 phase VPWM drives

Motor frame size (mm)	115ED			115UD		
Voltage (Vrms)	200-240			380-480		
Frame length	B	C	D	B	C	D
Continuous stall torque (Nm)	10.20	14.60	18.80	10.20	14.60	18.80
Peak torque (Nm)	30.60	43.80	56.40	30.60	43.80	56.40
Standard inertia (kgcm ²)	4.41	6.39	8.38	4.41	6.39	8.38
Winding thermal time constant (sec)	164	168	175	164	168	175
Motor weight unbraked (kg)	6.95	8.72	10.49	6.95	8.72	10.49
Motor weight braked (kg)	8.45	10.22	11.99	8.45	10.22	11.99
Number of poles	10	10	10	10	10	10
Speed 2,000 (rpm)	Kt (Nm/A) = 1.40			2.4		
	Ke (V/krpm) = 85.50			147.00		
Rated torque (Nm)	8.60	11.90	15.60	8.60	11.90	15.60
Stall current (A)	7.29	10.43	13.43	4.25	6.08	7.83
Rated power(kW)	1.80	2.49	3.27	1.80	2.49	3.27
R (ph-ph) (Ohms)	1.4	0.77	0.61	4.41	2.41	1.80
L (ph-ph) (mH)	12.8	7.9	6.6	40.6	24.7	19.5
Recommended power conn' size	1	1	1	1	1	1
Speed 3,000 (rpm)	Kt (Nm/A) = 0.93			1.60		
	Ke (V/krpm) = 57.00			98.00		
Rated torque (Nm)	7.70	10.50		7.70	10.50	13.60
Stall current (A)	10.97	15.70		6.38	9.13	11.75
Rated power(kW)	2.42	3.30		2.42	3.30	4.27
R (ph-ph) (Ohms)	0.58	0.39		1.83	1.21	0.78
L (ph-ph) (mH)	5.4	4.0		16.9	12.7	8.7
Recommended power conn' size	1	1		1	1	1

$\Delta t = 100^\circ\text{C}$ winding 40°C maximum ambient
All data subject to $\pm 10\%$ tolerance

Stall torque, rated torque and power relate to maximum continuous operation tested in a 20°C ambient at 12 kHz drive switching frequency

All other figures relate to a 20°C motor temperature.

Maximum intermittent winding temperature is 140°C

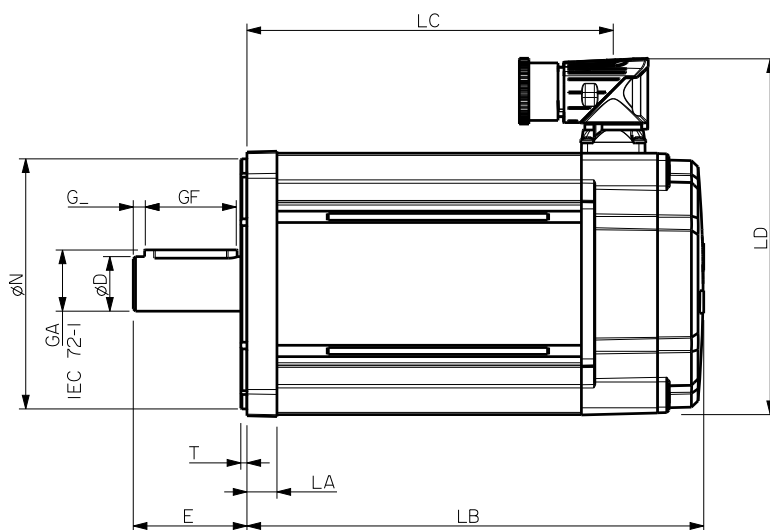
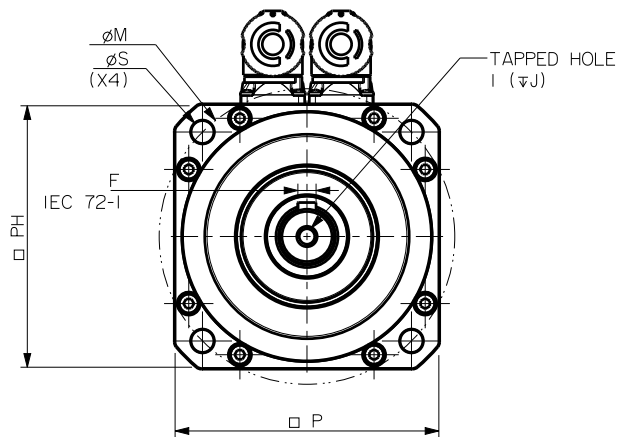

Motor dimension (mm)

	Feedback EC, FC/VF, WF				Flange thickness	Register length	Register diameter	Overall height	Flange square	Fixing hole diameter	Fixing hole PCD	Motor housing	Mounting bolts
	Unbraked length		Braked length										
	LB (± 1)	LC (± 1.0)	LB (± 1)	LC (± 1.0)	LA (± 0.5)	T (± 0.1)	N (j6)	LD (± 0.3)	P (± 0.3)	S (H14)	M (± 0.5)	PH (± 0.5)	
115B	193.8	154.0	230.9	191.1	13.2	2.70	110.0	156.5	116.0	10.00	130.0	115.0	M8
115C	223.8	184.0	260.9	221.1									
115D	253.8	214.0	290.9	251.1									

	Feedback FB, EB/CA/SA, RA		Feedback AE	
	Unbraked length	Braked length	Unbraked length	Braked length
	LB (± 1.0)	LB (± 1.0)	LB (± 1.0)	LB (± 1.0)
115B	206.8	243.9	183.8	220.9
115C	236.8	273.9	213.8	250.9
115D	266.8	303.9	243.8	280.9

Shaft dimensions (mm)

	Shaft diameter	Shaft length	Key height	Key length	Key to shaft end	Key width	Tapped hole thread size	Tapped hole depth
	D (j6)	E	GA	GF	G	F (h9)	I	J (± 1.0)
24.0 Std	24.0	50.0	27.0	40.0	5.3	8.0	M8 x 1.25	20.0

2.3.5 Frame size 142 for 3 phase VPWM drives

Motor frame size (mm)	142ED			142UD		
Voltage (Vrms)	200-240			380-480		
Frame length	C	D	E	C	D	E
Continuous stall torque (Nm)	25.00	31.50	38.00	25.00	31.50	38.00
Peak torque (Nm)	74.90	94.50	114.00	74.90	94.50	114.00
Standard inertia (kgcm ²)	17.00	22.10	27.20	17.00	22.10	27.20
Winding thermal time constant (sec)	245	251	256	245	251	256
Motor weight unbraked (kg)	12.74	15.39	18.04	12.74	15.39	18.04
Motor weight braked (kg)	14.82	17.47	20.12	14.82	17.44	20.12
Number of poles	10	10	10	10	10	10
Speed 1,000 (rpm)	Kt (Nm/A) = 2.8 Ke (V/krpm) = 171.0					
Rated torque (Nm)	23.3	29	34.5			
Stall current (A)	8.9	11.2	13.6			
Rated power (kW)	2.44	3.04	3.61			
R (ph-ph) (Ohms)	1.36	0.94	0.72			
L (ph-ph) (mH)	21.3	15.2	12.3			
Recommended power conn' size	1	1	1			
Speed 1,500 (rpm)	Kt (Nm/A) = 3.2 Ke (V/krpm) = 196.0					
Rated torque (Nm)				22.3	27	31.7
Stall current (A)				7.8	9.8	11.9
Rated power (kW)				3.5	4.2	5
R (ph-ph) (Ohms)				1.36	0.94	0.72
L (ph-ph) (mH)				21.3	15.2	12.3
Recommended power conn' size				1	1	1
Speed 2,000 (rpm)	Kt (Nm/A) = 1.4 Ke (V/krpm) = 85.5					
Rated torque (Nm)	21.4	25.7	29.6	21.4	25.7	29.6
Stall current (A)	17.8	22.5	27.1	10.4	13.1	15.8
Rated power (kW)	4.48	5.38	6.20	4.48	5.38	6.2
R (ph-ph) (Ohms)	0.34	0.24	0.18	0.79	0.62	0.49
L (ph-ph) (mH)	5.3	3.8	3.1	12.2	9.7	8.3
Recommended power conn' size	1.5	1.5	1.5	1	1	1
Speed 3,000 (rpm)	Kt (Nm/A) = 0.93 Ke (V/krpm) = 57.0					
Rated torque (Nm)	18.4	20.9		18.4	20.9	23
Stall current (A)	26.9	33.9		15.6	19.7	23.8
Rated power (kW)	5.78	6.57		5.78	6.57	7.23
R (ph-ph) (Ω)	0.12	0.10		0.34	0.24	0.18
L (ph-ph) (mH)	1.9	1.6		5.3	3.8	3.1
Connection type	1.5	1.5		1	1.5	1.5

Δt= 100 °C winding 40 °C maximum ambient

All data subject to ±10 % tolerance

Stall torque, rated torque and power relate to maximum continuous operation tested in a 20 °C ambient at 12 kHz drive switching frequency

All other figures relate to a 20 °C motor temperature.

Maximum intermittent winding temperature is 140 °C

Motor dimension (mm)

	Unbraked length		Braked length		Flange thickness	Register length	Register diameter	Overall height	Flange square	Fixing hole diameter	Fixing hole PCD	Motor housing	Mounting bolts
	LB (± 1)	LC (± 1.0)	LB (± 1)	LC (± 1.0)									
142C	217.0	182.5	282.5	248.0				183.5					
142D	247.0	212.5	312.5	278.0	14.0	3.4	130.0	183.5-204.5	142.0	12.0	165.0	142.0	M10
142E	277.0	242.5	342.5	308.0				183.5-204.5					

Shaft dimensions (mm)

	Shaft diameter	Shaft length	Key height	Key length	Key to shaft end	Key width	Tapped hole thread size	Tapped hole depth
	D (j6)	E	GA	GF	G	F (h9)	I	J (± 1.0)
32.0Std	32.0	58.0	35.0	50.0	3.0	10.0	M12 x 1.75	29.0

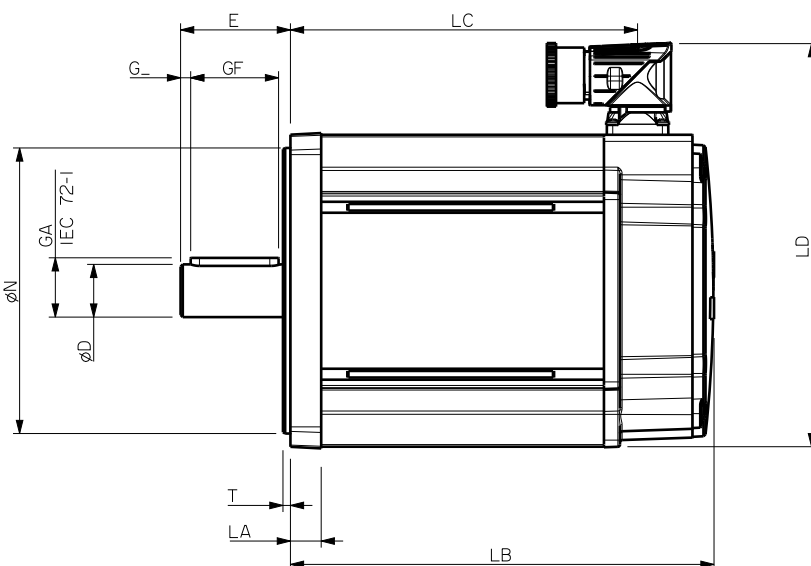
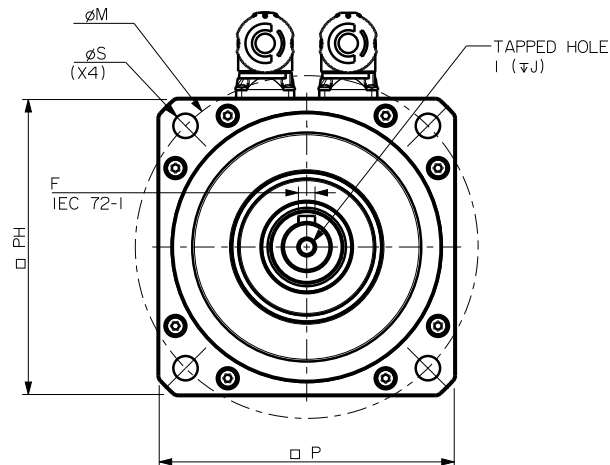

2.3.6 Frame size 190 for 3 phase VPWM drives

Motor frame size (mm)	190ED			190UD		
Voltage (Vrms)	200-240			380-480		
Frame length	C	D	F	C	D	F
Continuous stall torque (Nm)	52.00	62.00	85.00	52.00	62.00	85.00
Peak torque (Nm)	156.00	186.00	255.00	156.00	186.00	255.00
Standard inertia (kgcm ²)	54.6	70.9	103.5	54.6	70.9	103.5
Winding thermal time constant (sec)	311	316	324	311	316	324
Motor weight unbraked (kg)	27.74	34.30	47.42	27.74	34.30	47.42
Motor weight braked (kg)	31.38	37.94	56.74	31.38	37.94	56.74
Number of poles	10	10	10	10	10	10
Speed 1,000 (rpm)	Kt (Nm/A) = 2.8			Ke (V/krpm) = 171.0		
Rated torque (Nm)	49	56.5	77.5			
Stall current (A)	18.6	22.1	30.4			
Rated power(kW)	5.13	5.92	8.12			
R (ph-ph) (Ohms)	0.47	0.4	0.23			
L (ph-ph) (mH)	12.3	10.4	6.8			
Recommended power conn' size	1.5	1.5	1.5			
Speed 1,500 (rpm)	Kt (Nm/A) = 3.2			Ke (V/krpm) = 196.0		
Rated torque (Nm)				46.2	52.2	68.5
Stall current (A)				16.3	19.4	26.6
Rated power(kW)				7.26	8.2	10.76
R (ph-ph) (Ohms)				0.57	0.4	0.23
L (ph-ph) (mH)				14.2	10.4	6.8
Recommended power conn' size				1.5	1.5	1.5
Speed 2,000 (rpm)	Kt (Nm/A) = 1.4			Ke (V/krpm) = 85.5		
Rated torque (Nm)	42.5			42.5		
Stall current (A)	37.1			21.7		
Rated power(kW)	8.9			8.90		
R (ph-ph) (Ohms)	0.12			0.34		
L (ph-ph) (mH)	3.1			8.2		
Recommended power conn' size	1.5			1.5		

$\Delta t = 100^\circ\text{C}$ winding 40°C maximum ambient
All data subject to $\pm 10\%$ tolerance

Stall torque, rated torque and power relate to maximum continuous operation tested in a 20°C ambient at 6 kHz drive switching frequency

All other figures relate to a 20°C motor temperature.

Maximum intermittent winding temperature is 140°C

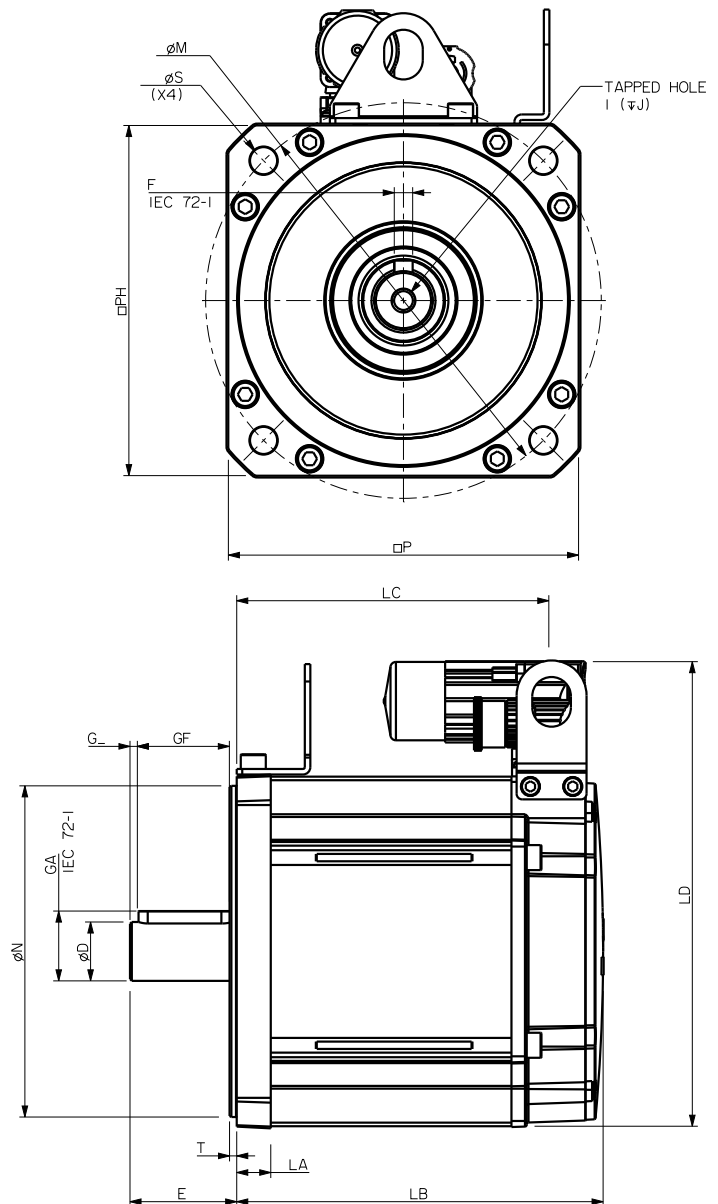

Motor dimension (mm)

	Unbraked length		Braked length		Flange thickness	Register length	Register diameter	Overall height	Flange square	Fixing hole diameter	Fixing hole PCD	Motor housing	Mounting bolts
	LB (± 0.9)	LC (± 1.0)	LB (± 0.9)	LC (± 1.0)									
190C	220.6	191.1	319.1	289.6	18.5	3.9	180.0	252.5	190.3	14.5	215.0	190.0	M12
190D	250.6	221.1	349.1	319.6									
190F	310.6	281.1	409.1	379.6									

Shaft dimensions (mm)

	Shaft diameter	Shaft length	Key height	Key length	Key to shaft end	Key width	Tapped hole thread size	Tapped hole depth
	D ($\phi 6$)	E	GA	GF	G	F (h9)	I	J (± 1.0)
38.0 Std	38.0	80.0	41.0	70.0	4.6	10.0	M12 x 1.75	29.0

3 Generic information

3.1 Performance definitions

Stall torque This is the maximum torque within the continuous zone at zero speed.

Maximum continuous torque ratings may be intermittently exceeded for short periods provided that the winding Δt max temperature is not exceeded.

Δt max = 100 °C over a maximum ambient of 40 °C for Unimotor fm and Unimotor hd.

Stall current Stall current = Stall torque / k_t

Motor label and performance tables quote stall current when motor is at full power in a maximum ambient of 40 °C.

Rated speed This is the maximum speed of the motor within the continuous zone. The motor speed can be controlled to any speed subject to the voltage limits and drive constraints as shown by the intermittent zone on the graph (see performance graphs - section 4).

Ke voltage constant This is the phase to phase rms voltage generated at the stator when the shaft is back driven at 1,000 rpm with the rotor at 20 °C.

Kt torque constant A brushless motor delivers torque proportional to the current, such that torque = $K_t \times$ current.

Where $K_t = 0.0165 \times K_e$ (at 20 °C).

Magnets used on all motors are affected by temperature such that K_e and K_t reduce with increasing temperatures of the magnets. The reductions depend upon the magnet type and material grade used.

Winding thermal time constant The thermal time constant of the winding with respect to the stator temperature as a reference in the exponential temperature rise given by the formula:

$$\text{Winding temperature at time } t \text{ seconds} = T_0 + T_1(1 - e^{-t/tc})$$

Where T_0 is the initial temperature, T_1 is the final winding temperature and tc = thermal time constant (seconds)

Note that temperature = 63.2 % of T_1 when $t = tc$

A thermal protection trip is provided by the drive, based upon calculations using elapsed time, current measurement, and the parameter settings set by the user or directly from the motor map.

Unimotor fm and Unimotor hd windings are ultimately protected by thermistor devices in the winding overhangs. These must be connected to the appropriate drive inputs via the motor feedback signal connector.

Rated power This is the product of the rated speed (radian/sec) and the rated torque (Nm) expressed in Watts (W).

Δt temperature Δt temperature is the temperature difference between the copper wires of the motor winding and the ambient air temperature surrounding the motor.

The maximum Δt temperature permitted is 100 °C over a maximum ambient of 40 °C.
(i.e. a maximum winding temperature of 140 °C)



3.2 Motor derating

Motor derating

Any adverse operating conditions require that the motor performance be derated. These conditions include: ambient temperature above 40 °C, motor mounting position, drive switching frequency or the drive being oversized for the motor.

Ambient temperature

The ambient temperature around the motor must be taken into account. For ambient temperatures above 40 °C the torque must be derated using the following formula as a guideline. (Note: Only applies to 2,000/3,000 rpm motors and assumes copper losses dominate.)

$$\text{New derated torque} = \text{Specified torque} \times \sqrt{[1 - ((\text{Ambient temperature} - 40^\circ\text{C}) / 100)]}$$

For example with an ambient temperature of 76 °C the new derated torque will be 0.8 x specified torque.

Thermal test conditions

The performance data shown has been recorded under the following conditions. Ambient temperature 20 °C, with the motor mounted on a thermally isolated aluminum plate as shown below.

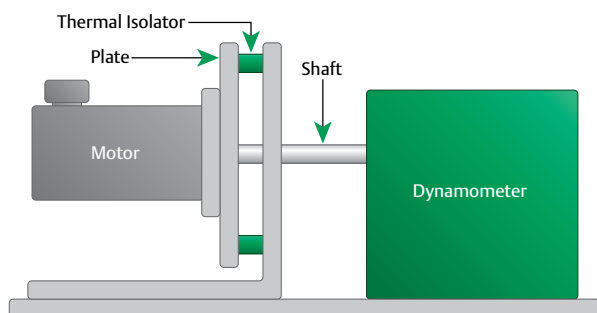

Motor type/frame	Aluminium heatsink plate
055 mm	110 x 110 x 27 mm
067-089 mm	250 x 250 x 15 mm
115-142 mm	350 x 350 x 20 mm
190 mm	500 x 500 x 20 mm

Mounting arrangements

The motor torque must be derated if:

- The motor mounting surface is heated from an external source, such as a gearbox.
- The motor is connected to a poor thermal conductor.
- The motor is in a confined space with restricted air flow.

Drive switching frequency

Most Unidrive M and Digitax ST nominal current ratings are reduced for the higher switching frequencies. See the appropriate drive manual for details.

See the table below for the motor derate factors. These figures are for guidance only.

3.2.1 Unimotor fm derate factors

Switching frequency	075		095		115		142		190		250
	A-D	A-E	A-C	D-E	A-C	D-E	A-B	C-H	D-F		
3 kHz	0.93	0.88	0.89	0.84	0.87	0.81	0.98	N/A	0.88		
4 kHz	0.94	0.91	0.91	0.87	0.91	0.86	0.99	0.55	0.90		
6 kHz	0.95	0.93	0.93	0.90	0.94	0.89	0.99	0.77	0.94		
8 kHz	0.98	0.97	0.97	0.95	0.97	0.96	1	0.90	0.98		
12/16 kHz	1	1	1	1	1	1	1	1	1		

Note

Only applies to motors up to 3,000 rpm (rms) or lower. Assumes copper losses dominate on all frame sizes. Derate factor is applied to stall torque, rated torque, stall current and rated power.

3.2.2 Unimotor hd derate factors

Switching frequency	Motor type/frame					
	055	067	089	115	142	190
3 kHz	0.92	0.93	0.89	0.89	0.83	0.90
4 kHz	0.93	0.94	0.91	0.92	0.85	0.95
6 kHz	0.95	0.95	0.95	0.96	0.88	1
8 kHz	0.96	0.98	0.97	0.98	0.91	1
12/16 kHz	1	1	1	1	1	1

Note

Only applies to motors up to 3,000 rpm (rms) or lower. Assumes copper losses dominate on all frame sizes. Derate factor is applied to stall torque, rated torque, stall current and rated power.

3.3 Nameplate

3.3.1 Unimotor fm/hd

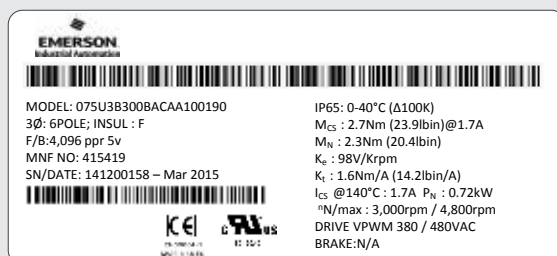

Model	This is the full part number of the motor
3Ø	Indicates this motor is a 3 phase motor
POLES	Number of poles: → 055-8 poles - 4 pole pairs (hd only) → 067-190 - 10 poles - 5 pole pairs (hd only) → 075-142 - 6 poles - 3 pole pairs (fm only) → 190-8 pole - 4 pole pairs (fm only) → 250-10 poles - 5 pole pairs (fm only)
Insul	Windings are built to class F (155 °C)
F/B	This gives the feedback device, count and working voltage or the feedback type
MNF NO	This is the work order for the motor
S/N DATE	The serial number and date the motor was manufactured
IP	Ingress protection rating IP 65S
M_{cs}	The stall torque at stall current

M_N	The rated torque of the motor
Ke	This is the AC Volts per 1,000 rpm with the motor at 20 °C
Kt	Value shown is for the magnet's temperature at 20 °C
I_{cs}	The constant stall current at the maximum winding temperature of 140 °C
P_N	The rated power of the motor
°N/max	The rated speed/ this is the maximum speed allowed when taking into account these three factors: 1) Maximum drive voltage 2) Maximum encoder speed 3) Maximum mechanical speed
Drive VPWM	This indicates that the motor is for use with a voltage pulse width modulated drive with the supply voltage shown
Brake	The current, that rated torque and the operation voltage for the brake or N/A if the brake is not fitted

3.4 Motor selection

A reliable servo system depends upon the initial system design and correct selection of the motor, feedback, gearbox and drive. To ensure success careful attention should be paid to the following points:

- Speed, acceleration and inertia
- Peak and rms torque
- Motor feedback type
- Gear ratios
- Drive system operational mode
- Thermal effects
- Environmental conditions
- Mechanical restrictions
- Cost of motor-drive combination

It is necessary to estimate the root mean square (rms) torque value of the load. Where the motor has varying duty cycles it may be necessary to consider the worst case only.

Never exceed the maximum peak torque ratings.

Calculate the rms load torque at the motor and ensure that this is less than the motor rated torque. An additional allowance should be made on the load for inefficiencies and tolerance.

Choose a suitable motor within the size limitations of the installation. The frame size and motor speed may be selected using the performance data. Look for the rated torque at the appropriate temperature.

3.5 Checklist of operating details

Complete this checklist to help select which Unimotor fm best suits your application requirements.

Torque speed

- What motor operating speed do you require (rpm)?
 - 500
 - 1,000
 - 2,000
 - 3,000
 - 4,000
 - 6,000
 - Other (non standard speed)
- What is the rms torque?
Decide on switching frequencies for the drive, and derate motor or drive accordingly
- If the ambient temperature is above 40 °C, apply a derating factor. If the motor is mounted to a hot interface; or interfaced with a low thermal mass; or high thermal resistance; apply a derating factor. Torque ratings of motors are stated in controlled conditions mounted on a reference front plate. Details can be found in the *Performance data* selection
- Inertia mismatch (ratio of the motor inertia to load inertia reflected to motor shaft) can be as high as 3:1 for acceleration rates of 1,000 rad/s² for a typical system. Larger mismatches or acceleration can be tolerated with a rigid mechanical system and high resolution feedback
- Do you require a brake?

Motor mounting

- Does the motor fit the machine?
Make allowances for cables and connections.
- Do you require an output key?
 - Output key
 - Plain shaft

Feedback

- Do you want an encoder or resolver?
 - Incremental
 - SinCos Multi turn
 - SICK Hiperface
 - Heidenhain EnDat
 - Inductive absolute
 - High accuracy
 - SinCos single turn
 - SICK Hiperface
 - Heidenhain EnDat
 - Inductive
 - High accuracy
 - Resolver

Electrical connections

- Connectors
 - Power and signal 90 ° rotatable
 - Power 90 ° rotatable and signal vertical
 - Power and signal vertical

Other options

- Do you require a gearbox?
 - Yes see Dynobloc fm/hd catalogue
 - No
- For further details on customer special motors, contact us.

3.6 Other points to consider

Torque and temperature

- The maximum allowable temperature of the motor windings or feedback device should not be exceeded. The windings have a thermal time constant ranging from 90 seconds to over an hour. Dependent upon motor temperature the motor can be overdriven for shorter periods without exceeding the temperature limitations. The motor winding thermal time constant should be set-up in the drive; this parameter is used for thermal shock (I^2t) calculations within the drive
- The motor winding thermal time constant should be large in comparison with the medium term periods of high rms torque
- Ensure that the drive's features, such as switching frequency, waveforms, peak and continuous currents are suitable for the application. Low switching frequencies of the drive will require motor derating
- Torque estimates should include friction and acceleration (and hence inertia) calculations
- Consider the motor cooling effects; for example, is the conductive thermal path adequate? Is the motor mounted on a gearbox or heat source?
- Ensure that the motor and drive can meet the short term peak torque requirements

Braking

- The installation may require static parking brake

Inertia

- Ensure that the motor has correct inertia matching to suit the acceleration requirements. Consider inertia load matching especially for acceleration levels above 1,000 rad/s². Motors with larger frame diameters have higher inertia. Higher inertia rotor options are available

Environmental conditions

- Other environmental factors, such as vibration, pressure, shock, heat and hazardous zones should be considered

Cables

- The cable lengths required for the installation should be considered. For maximum cable length, see *Maximum cable length* in the *Cable* section. Compliance with both Safety and EMC regulations should be ensured
- Ensure motor is mounted firmly and properly earthed. Screen all cables to reduce system noise and EMC

Feedback

- To achieve an efficient system it is necessary to ensure stiff mechanical connections and couplings to all rotating parts, so that a high servo bandwidth can be achieved. This will improve stability and enable higher servo gains to be set, ensuring higher accuracy and positional repeatability
- High resolution feedbacks will increase stability and allow greater acceleration or inertia mismatch

Bearing loads

- Check the radial and axial loadings are within the limits of the motor

3.7 Special motor requests

Leroy-Somer offer many 'special' motors. These motors are designed to meet a specific customer's requirements.

Special motors are denoted by a code on the end of the part number. S*** 3 or 4 digits; e.g. 115U3E100BACAA115240-SON (special coating)

To request a special motor please contact Leroy-Somer with the customer requirements. A product enquiry form will be raised and R&D/Engineering will investigate the feasibility of the request. If acceptable then a special part number reference will be allocated to the motor and a quote will be issued.

Once an order is placed a Product Approval Schedule (PAS) form will be raised and sent to the Automation Center for approval.

Special motors can include:

- Special paint finishes or unpainted motors
- Special motors with customer specific connector wiring
- Special motors with customer specific brakes
- Special motors with customer specific shaft dimension
- Special motors for harsh environments motors

3.8 Calculating load torque

In any application, the load consists of various torque loads plus acceleration and deceleration of inertia.

Constant torque periods

Periods where a torque is maintained at constant or near constant motor speeds.

Acceleration and deceleration

Torque is required to achieve acceleration and deceleration. Acceleration times of less than one second can often be achieved using peak torque capability of the drive and motor.

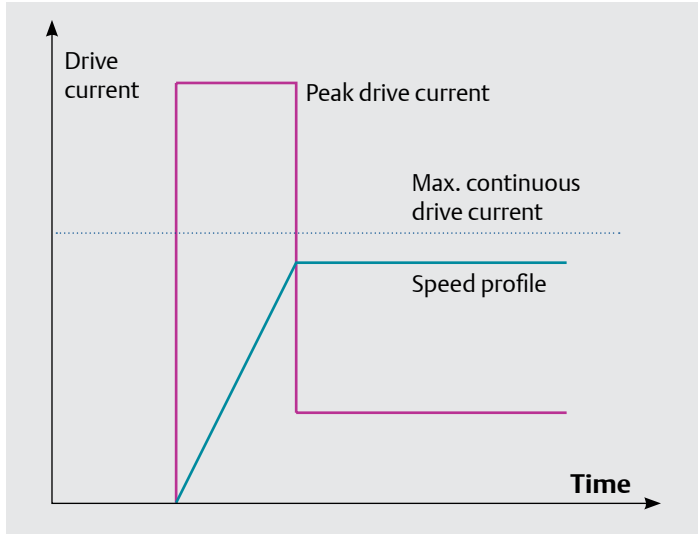

Note

Peak drive current may be set by drive control to the motor's continuous current rating. If this is required, check that it is within the drive's capability. Medium periods of up to 200 % over current are often acceptable for the motor, provided that the heating effects are not too rapid and that the motor thermal time constant is long in comparison.

Inertia formula and accelerating or decelerating torques:

Inertial loads on a common shaft may be added together. Inertial loads may be reflected from the output of a reduction gearbox to the motor by dividing the output ratio by the square of the ratio.

$$\text{Total inertia} = \text{reflected inertia load at motor} + \text{motor inertia}$$

rms torque for a repetitive duty cycle:

Draw a graph of torque (T) against time for one complete repetitive cycle of events (or choose the worst case of various events). Make the torque axis vertical. On the same graph, draw the speed profile against time for one cycle.

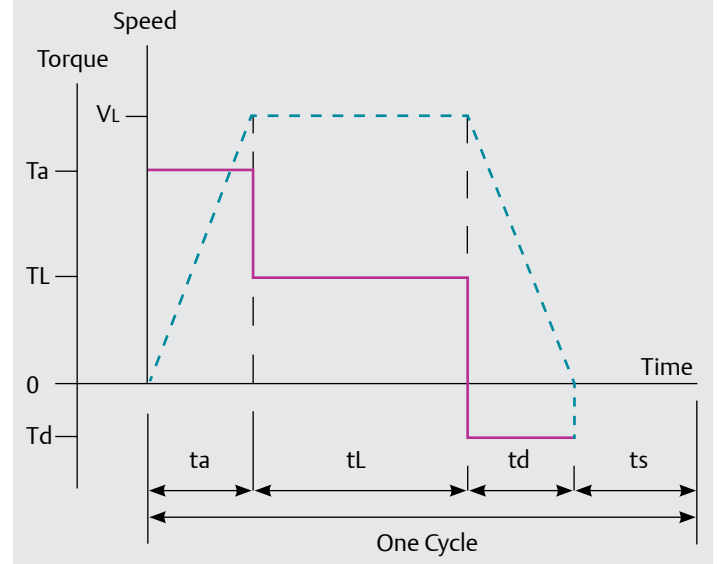

From the above speed-torque diagram calculate the rms torque using the formula:

$$T_{rms} = \sqrt{\frac{T_a^2 \times t_a + T_L^2 \times t_L + T_d^2 \times t_d + T_s^2 \times t_s}{t_a + t_L + t_d + t_s}}$$

Where:

- Ta** = Acceleration torque (Nm)
- TL** = Load torque (Nm)
- Td** = Deceleration torque (Nm)
- ts** = Dwell torque (Nm=0)
- tL** = On load running time (s)
- td** = Deceleration time (s)
- ts** = Dwell time (s)
- VL** = Full load speed (rpm)

Example

In an application where the torque speed profile is as above with **Ta** = 20 Nm, **TL** = 5 Nm, **Td** = -10 Nm, **ta** = 20 ms, **tL** = 5 s, **td** = 30 ms, **ts** = 3 s, **VL** = 3,000 rpm, **Ts** = 0 calculate the rms torque for this application.

$$T_{rms} = \sqrt{\frac{20^2 \times 0.02 + 5^2 \times 5 + 10^2 \times 0.03 + 0^2 \times 3}{0.02 + 5 + 0.03 + 3}}$$

$$T_{rms} = \sqrt{\frac{136}{8.05}}$$

$$T_{rms} = 4.11 \text{ Nm}$$

15 % tolerance required hence the rms torque for this application = **4.73 Nm**

3.9 Understanding motor heating effects

During operation, the motor is subjected to heating effects from several sources. Some of these are obvious; others obscure. Whilst the motor specification allows for most of these heating effects, others depend on the application. This section examines some of the causes of motor heating.

Motor copper losses

Motor copper loss is a product of the rms current squared and the resistance of the motor windings. It includes ripple currents, determined by the switching frequency of the drive and the inductance of the motor. The inductance of the winding is generally low, so that the maximum drive frequencies should be selected commensurate with drive heating losses. Data in this manual is for switching frequencies as stated in the performance data section. If lower frequencies are used, motor performance is reduced.

Motor copper loss also includes losses arising from waveform distortions of either the drive or motor or both. The motor's back EMF waveform is sinusoidal and of low harmonic distortion. If lower frequencies are used, the drive current has higher distortion and hence the motor performance is reduced.

Motor current depends on the torque demanded by the load at any instant. This is normally given by the motor torque constant (K_t) in Nm/A. Although regarded as a constant, K_t decreases slightly when the motor is at maximum temperature.

The K_e for a brushless three phase motor is always quoted Volts(rms) per krpm, since the motor back emf is sinusoidal.

Motor iron losses

Motor iron loss is a heating effect produced in the motor laminations. It is caused by the rotating magnetic field cutting through the laminations, the higher the speed the higher the losses. For this reason the motor stall torque is greater than the motor rated torque at speed.

Iron loss depends on the strength of the magnetic field and type of laminations material.

Friction and windage

The bearings, oil seals and the air resistance to rotor speed cause internal friction. Its effect is relatively small and is included in the data provided.

Thermal protection

An incorrect system set up can give rise to excessive motor temperatures. This can be guarded against by the use of the motor thermistor protection facility.

Servo motor/drive system faults

Common but often unnoticed causes of motor overheating can be created by:

- Instability (self induced oscillation) within the overall servo feedback system
- Incorrect parameter settings in the drive protection system, for example peak current, and I^2t (thermal protection calculation for the drive)

The increase in resistance is measured by the drive and a “th trip” will occur. Only once the motor has cooled can the trip be cleared.

The installer must connect the motor thermistor to the drive to cause motor power shutdown in the event of overheating.

It is the installer's responsibility to ensure that this protection facility is properly connected and set at the drive.

Failure to ensure the correct operation of the protection facility invalidates the warranty in respect of a burnt out winding.

The ambient temperature of the environment into which the Unimotor is mounted must be considered.

Unimotor PTC 145 °C

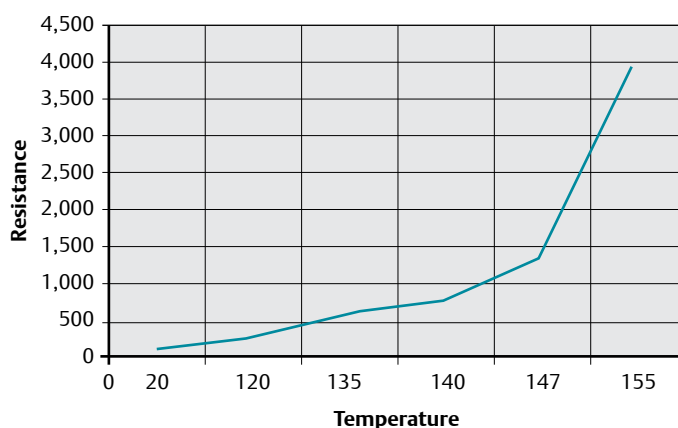

Thermistor protection

A PTC thermistor rated to 145 C, is built into the motor windings and is used to protect the motor against overheating problems.

The device remains a low resistance until a critical temperature is reached, where it will then switch to a very high resistance.

Unimotor KTY 84 -130 °C

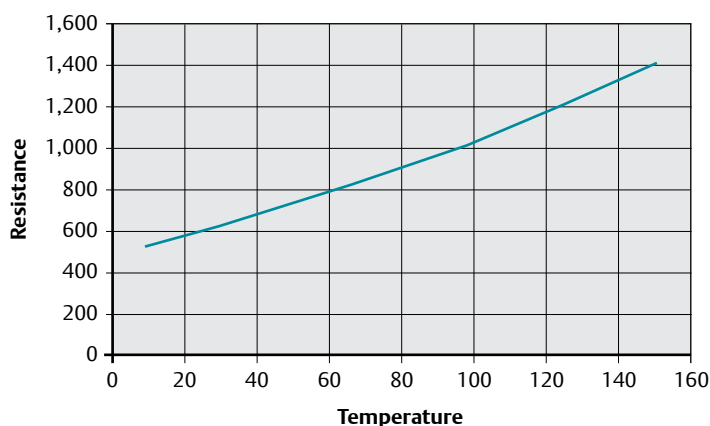

KTY protection

A KTY 84-130 temperature sensor is built into the motor windings and is used to protect the motor against overheating problems. This device returns a resistance proportional to the winding temperature.

Fan boxes

The Unimotor fm and hd range can support a fan box unit, this can be retrofitted to the motor in the field and is used in applications where the motor's rated performance is not being exceeded and the fan box is used just to maintain a reduced motor temperature.



Fan Box units	Clearance distance behind fan box	Voltage	Free Air flow	Fan current rating
075 motor	40mm	230V AC	50 m ³ /h	0.05A
095 motor	40mm	230V AC	67 m ³ /h	0.05A
115 motor	40mm	230V AC	160 m ³ /h	0.08A
142 motor	50mm	230V AC	180 m ³ /h	0.07A
190 motor	60mm	230V AC	325 m ³ /h	0.13A

Fan box wiring

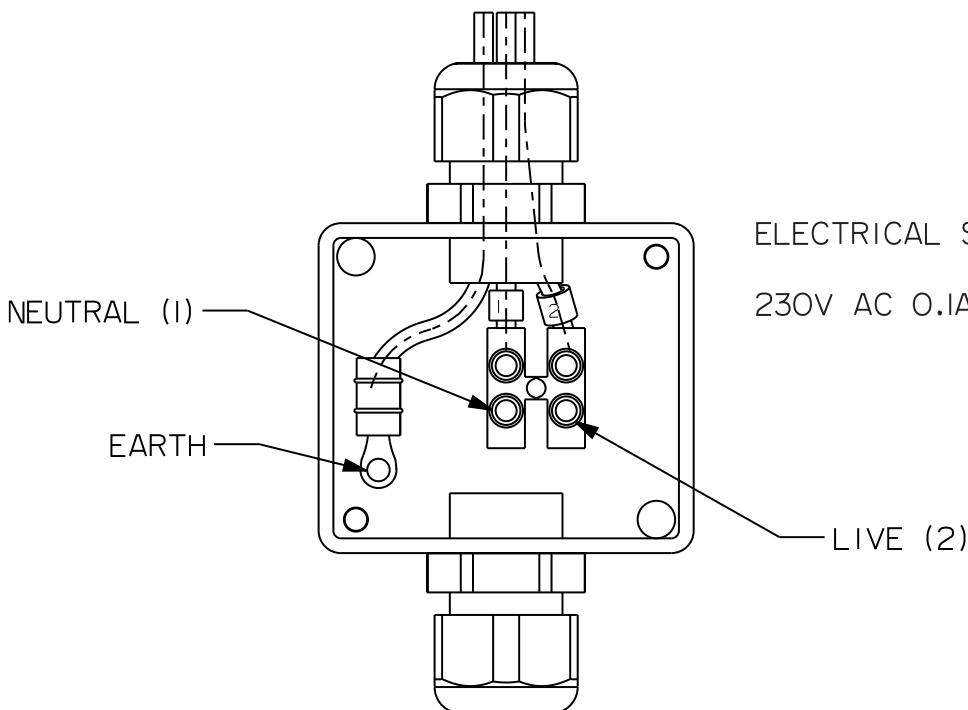

3.10 Feedback selection

Feedback device order code	Feedback type	Manufacturer	Encoder supply voltage	SinCos cycle or incremental pulses per revolution	Resolution available to position loop ^{2&3}	Absolute multi-turn revolutions	Feedback accuracy ¹	Single cable connector available ⁴	Serial communication protocol	Frame size compatibility
55-67 Motors										
AR	Resolver	LTN RE-15	7 Vdc Excitation 5kHz	1 Transformation ratio 0.5	Medium 16384 (14 bits)	-	Low +/- 600"	-	-	
CR	Incremental Encoder	R35i	5 Vdc ±10%	4096	Medium 16384 (14 bits)	-	Medium +/- 150"	-	-	
EM (Multi-turn)	Inductive EnDat SinCos	EQI 1130	5 Vdc ±5%	16	High 2.62x10 ⁵ (18 bits)	4096 (12 bits)	Low +/- 480"	-	EnDat 2.1 / EnDat 01	
FM (Single-turn)		ECI 1118				-		-		
EG (Multi-turn)	Inductive EnDat only	EQI 1131	3.6-14 Vdc	N/A	High 5.24x10 ⁵ (19 bits)	4096 (12 bits)	Medium +/- 120"	6 wire HMC6	EnDat 2.2 / EnDat 22	
FG (Single-turn)		ECI 1119				-		6 wire HMC6		
TL (Multi-turn)	Optical Hiperface SinCos	SKM 36	7 - 12 Vdc	128	High 1.31x10 ⁵ (17 bits)	4096 (12 bits)	Medium +/- 120"	-	Hiperface	
UL (Single-turn)		SKS 36				-		-		
EN (Multi-turn)	Optical EnDat only	EQN 1135	3.6-14 Vdc	N/A	Very High 8.38x10 ⁶ (23 bits)	4096 (12 bits)	High +/- 60"	6 wire HMC6	EnDat 2.2 / EnDat 22	Only available on 067 HD frame size
FN (Single-turn)		ECN 1123				-		6 wire HMC6		
75 -250 Motors										
AE	Resolver	Size 52	6 Vdc Excitation 6kHz	1 Transformation ratio 0.31	Medium 16384 (14 bits)	-	Low +/- 720"	-		
CA	Incremental Encoder	CFS50	5 Vdc ±10%	4096	Medium 16384 (14 bits)	-	High +/- 60"	-		
VF (Multi-turn)	Capacitive Hiperface SinCos	SEL 52	7 - 12 Vdc	16	Medium 16384 (14 bits)	4096 (12 bits)	Medium +/- 360"	-	Hiperface	Only available on 089, 115 and 142 frame sizes
WF (Single-turn)		SEK 52				-		-		
EC (Multi-turn)	Inductive EnDat SinCos	EQI 1331	4.75-10 Vdc	32	High 5.24x10 ⁵ (19 bits)	4096 (12 bits)	Medium +/- 380"	-	EnDat 2.2 / EnDat 01	Not available on 250 frame size
FC (Single-turn)		ECI 1319				-		-		
RA (Multi-turn)	Optical Hiperface SinCos	SRM 50	7 - 12 Vdc	1024	High 1.04x10 ⁶ (20 bits)	4096 (12 bits)	High +/- 52"	-	Hiperface	
SA (Single-turn)		SRS 50				-		-		
EB (Multi-turn)	Optical EnDat SinCos	EQN 1325	3.6-14 Vdc	2048	High 2.08x10 ⁶ (21 bits)	4096 (12 bits)	Very High +/- 20"	-	EnDat 2.2 / EnDat 01	
FB (Single-turn)		ECN 1313				-		-		
GB (Multi-turn)	Optical EnDat only	EQN 1337	3.6-14 Vdc	N/A	Very High 3.35x10 ⁷ (25 bits)	4096 (12 bits)	Very High +/- 20"	6 wire HMC6	EnDat 2.2 / EnDat 22	
HB (Single-turn)		ECN 1325				-		6 wire HMC6		
NA	Sensorless	-	-	-		-		Power connector only		Only available on Unimotor FM

1 The information is supplied by the feedback device manufacturer and relates to it as a standalone device. The value may change when mounted into the motor and connected to a drive. These values have not been verified by Control Techniques and Leroy-Somer.

2 The output from the resolver is an analogue output; the resolution is determined by the analogue to digital converter used; the value shown is when the resolver is used in conjunction with the SM-Resolver.

3 The sin and cosine outputs from the SinCos optical encoders are analogue outputs; with Unidrive M and Digitax ST the resolutions quoted above are when the encoder type is set to either SC EnDat or SC Hiperface depending on the encoder.

4 To be ordered with single cable connector, see connector options. 6 wire HMC6 must be ordered with KTY 84-130 thermistor, see inertia options.

3.11 Feedback terminology

Accuracy Accuracy is the measure of the difference between the expected position and actual measured value. Rotary feedback accuracy is usually given as an angle representing the maximum deviation from the expected position. Linear feedback accuracy is usually given as a distance representing the maximum deviation from the expected. Generally, as accuracy increases the cost of the feedback device increases.

Absolute encoder Absolute encoders output unique information for each mechanical measured position. With the motor shaft or plate in any position when the drive is turned on the feedback device will always be able to sense a unique position and transmit this value to the drive. For an absolute single turn rotary encoder these unique positions will be over one revolution.

When power is removed from the encoder and the shaft or plate moves the device will know its current position when the power is restored.

A non-absolute feedback mechanism must start from a known position, such as the index or marker pulse.

Bit A bit is short for **Binary Digit**. It is the smallest unit of information in a machine/drive. A single bit has a binary value of either 0 or 1. These bits do not normally exist on their own, but usually in groups. The larger the number of bits in a group the larger the amount of information that is available and thus the higher the resolution. This group can be converted to decimal using binary arithmetic. The group of bits can be converted to decimal by starting at the right most bit and multiplying each successive bit to the left by two. So for example a 12 bit number would give a decimal equivalent of 4,096 and a 19 bit number would give a decimal equivalent of 524,288.

Commutation All brushless AC permanent magnet motors require commutation information to enable the drive to synchronize the stator flux field with the rotor of the motor.

To ensure optimum torque at all rotor positions both when stationary and at speed the drive is required to maintain motor current in phase with the peak of the motor's sinusoidal waveform. The drive must therefore know the position of the rotor with respect to the stator at all times.

Commutation phase offset Most drives, including the Unidrive M and Digitax ST, provide a "Phase Offset" adjustment as a means of correctly setting the commutation position.

For feedback devices that are not aligned, the Unidrive M has an Encoder Phasing Test (Autotune) (Pr 5.012) that automatically creates a Phase Offset value (Encoder phase angle) (Pr 3.025).

All fm motor feedback devices are set to match the Unidrive M definition of zero phase offset, so that the drive may operate with zero phase offset adjustment, thus allowing interchange of motors between drives without further adjustment.

Note that not all drives have the same zero offset definition.

Commutation outputs Commutation outputs are used on devices that are non-absolute. For AC Synchronous 3 phase motors there are 3 commutation output signal channels from the feedback device, for example S1, S2 and S3.

The diagram below shows commutation outputs for 6 pole commutation (3 pole pairs). The 3 phase motor sinusoidal power from the drive runs synchronously with motor speed at $N/2$ cycles per revolution;

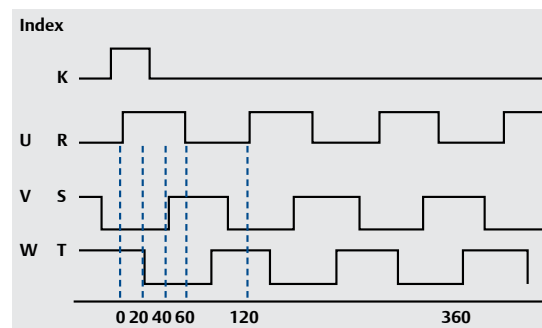

Where N = number of poles. For example, in a 6 pole motor, the encoder commutation tracks will output 3 pulses per channel per revolution and for an 8 pole motor the encoder commutation tracks will give 4 pulses per channel per revolution.

The commutation signals allow the drive to operate the motor at 'switch on' with only a small possible reduction in efficiency and torque in the motor. The best way to explain this is to use an example where an encoder is connected to a motor with 6 poles.

On power up the drive would look at the S1, S2 and S3 signals to determine where the stator is relative to the rotor or magnetic plate. This would give a known position that is within 60° electrical of an electrical cycle (20° mechanical). During this initial period, the drive assumes that it is in the middle of this 60° unknown region. So the worst case error of this is 30° electrical (10° mechanical), which equates to a drop of 13.4% in the rated torque when 100% current is delivered into the motor winding. When the drive is commanded to move the motor position, the stator is energized causing the plate or rotor to move. While the rotor or plate is moving, the drive detects that a signal switch (edge detection) has occurred on one of the commutation channels (S1, S2 or S3). At this point the drive knows exactly where it is in the electrical cycle and adjusts the field orientation to compensate for the error. At this point the drive switches over to using only the incremental signals for commutation and the commutation channels are no longer used.

Electronic nameplate Available on some feedback devices the electronic nameplate provides the facility to electronically store information about the motor and feedback device. This information can then automatically be used to configure the drive for operation.

Feedback terminology

Environment	<p>The environment is the external conditions that physically surround the Feedback device. The main factors that affect the feedback device are temperature and mechanical shock and vibration.</p> <p>Motors are designed to allow the feedback devices to be within their operational temperature limits. Generally it is assumed that there is free air movement around the motor. If the motor is positioned where there is little or no airflow or it is connected to a heat source such as a gearbox, it can cause the air temperature around the feedback device to be operating outside its recommended operating temperature and can lead to problems.</p> <p>Mechanical shock and vibration tends to be transmitted from the load through the motor shaft and into the feedback device. This should be considered when the motor and feedback device are being specified for the application.</p>	<p>1) Optical An electronic device using an optical disc. An absolute encoder with high resolution that employs a combination of absolute information, transmitted via a serial link, and Sine/CoSine signals with incremental techniques.</p>
Position	<p>The defined position is the location in a coordinate system which is usually in two or more dimensions.</p> <p>For a rotary feedback device this is defined as the location within one revolution. If it is a multi-turn device it is the location within one revolution plus the location within a number of rotations.</p> <p>For a linear feedback device this is defined as the distance from a known point.</p>	<p>2) Inductive/Capacitive: An electronic device using inductively coupled PCBs. An absolute encoder with medium resolution that employs a combination of absolute information, transmitted via a serial link, and Sine/CoSine signals with incremental techniques. This encoder can be operated with the drive using either Sine/CoSine or absolute (serial) values only. Positional information is absolute within 4,096 turns - i.e. position is not lost when the drive is powered down.</p> <p>Multi-turn As previous but with extra gear wheels included so that the output is unique for each shaft position and the encoder has the additional ability to count complete turns of the motor shaft up to 4,096 revolutions.</p>
Resolution	<p>The resolution of a feedback device is the smallest change in position or angle that it can detect in the quantity that it is measuring.</p> <p>Feedback resolution of the system is a function of the type of feedback device used and drive receiving the information.</p> <p>Generally, as the resolution of the feedback device increases the level of control that can be used in the servo system increases.</p> <p>As with accuracy, as the resolution of the device increases the cost increases.</p>	<p>Sensorless Synchronous Rotor Flux Control. Recommended for use on the FM motor range. The motor performance will be limited when operating at low speed when using high frequency injection mode. When using closed loop vector mode the motor performance will be as stated in the rating tables.</p> <p>Serial Interface Serial communication is available on some feedback devices. It is the process of sending data one bit at a time, sequentially, over a communication channel. The specification normally used to define this method of communication is the EIA485 specification. These can be synchronous, which means that they operate with additional clock channels. The main advantage of synchronous data transmission is that it can operate at high speed. A disadvantage is that if the receiver goes out of synchronization it can take time for it to resynchronize and data may be lost. Note that not all serial interfaces use the clock channels.</p> <p>Serial interface communication allows data to be sent and received from the feedback device. In addition to the position and speed data other information can be sent such as multi-turn count, absolute position and diagnostic information.</p>
Resolver	<p>A passive wound device consisting of a stator and rotor elements excited from an external source, such as an SM-Resolver, the resolver produces two output signals that correspond to the Sine and CoSine angle of the motor shaft. This is a robust absolute device of low accuracy, capable of withstanding high temperature and high levels of vibration. Positional information is absolute within one turn - i.e. position is not lost when the drive is powered down.</p>	<p>Single cable connectors Some encoders can be used with single cable connectors. For benefits and integration details please refer to encoder manufacturer's documentation. These encoders transmit all feedback information including motor thermistor values using serial data. For this reason 6 wire HMC6 encoders fitted with a single cable connector need to be fitted with a KTY thermistor. Please refer to connector and inertia options in the ordering code information.</p>
Incremental encoder	<p>An electronic device using an optical disc. The position is determined by counting steps or pulses. Two sequences of pulses in quadrature are used so the direction sensing may be determined and 4 x (pulses per rev) may be used for resolution in the drive. A marker pulse occurs once per revolution and is used to zero the position count. The encoder also provides commutation signals, which are required to determine the absolute position during the motor phasing test. This device is available in 4,096, 2,048 and 1,024 ppr versions. Positional information is non absolute - i.e. position is lost when the drive is powered down.</p>	<p>Synchronous If something is synchronous it means that events are coordinated in time. For serial interfaces this means that clock channels are used.</p> <p>Asynchronous If something is asynchronous it means that events are not coordinated in time. For serial interfaces this means that clock channels are not used.</p>
SinCos/ Absolute Encoders	<p>Types available are: Optical or Inductive - which can be single or multi-turn.</p>	<p>Speed Speed is the rate of change in position which can be either angular or linear traveled per unit of time. For rotational motors this is usually defined as revolutions per minute (rpm).</p> <p>Volatile Stored information will be lost when power is removed.</p> <p>Non volatile Stored information will not be lost when power is removed.</p>

3.12 Brake specification

Unimotor fm and hd may be ordered with an internal rear mounted spring applied parking brake. The brake works on a fail safe principle: the brake is active when the supply voltage is switched off and the brake is released when the supply voltage is switched on.

The standard parking brake is noted by the 5 code in the part number.

If a motor is fitted with a fail safe brake, take care not to expose the motor shaft to excessive torsional shocks or resonances when the brake is engaged or disengaged. Doing so can damage the brake.

Note.

Shunting the brake primary coil with an external diode to avoid switching peaks increases the release time considerably. This is usually required to protect solid state switches, or to reduce arcing at the brake relay contacts (Diode 1N4001 recommended)

SAFETY NOTE

The Fail-Safe Brake is for use as a holding brake with the motor shaft stationary.

Do NOT use it as a dynamic brake. Using it in this manner will cause brake wear and eventual failure. Emergency stop situations can contribute to brake wear and failure.



3.12.1 Unimotor fm

Motor frame	Supply volts	Input power	Static torque	Release time	Moment of inertia	Backlash **
			Parking brake (05)			
Size	Vdc	W	Nm	ms nom	kg.cm ² *	Degrees**
075	24	6.3	2.2	22	0.07	1.03
095	24	16	12.2	60	0.39	0.75
115	24	23	20	126	0.21	0.75
142	24	23	20	126	0.21	0.75
190(A-D)	24	25	42	95	1.85	0.77
190(E-H)	24	25	67	120	4.95	0.77
250	24	62	135	252	14.3	0.5

3.11.2 Unimotor hd

Motor frame	Supply volts	Input power	Static torque	Release time	Moment of inertia	Backlash **
			Parking brake (05)			
Size	Vdc	W	Nm	ms nom	kg.cm ² *	Degrees**
055	24	6.3	1.8	22	0.03	0.73
067	24	10.2	4	<50	0.073	0.75
089	24	23	10	<50	0.115	0.75
115	24	23	20	120	0.21	0.75
142	24	25	42	95	1.85	0.77
190(C-D)	24	25	67	120	4.95	0.77
190 F	24	54.5	100	TBA	7.72	0.75

*Note 1 kg.cm² = 1x10⁻⁴ kg.m² ** Backlash figure will increase with time

- The brake is intended for parking duty and is not for dynamic or safety use
- Refer to your Automation Center or Distributor if your application requires dynamic braking in emergency conditions
- To provide protection to the brake control circuit it is recommended that a diode is connected across the output terminals of the solid state or relay contacts devices
- Larger torque brakes are available as an option. Contact your Automation Center or Distributor for details
- Figures are shown at 20 °C brake temperature. Apply the derate factor of 0.7 to the standard brake torque figures if motor temperature is above 100 °C. A derate factor of 0.9 applies to the high energy brake if motor temperature is above 100 °C
- The brake will engage when power is removed

It is recommended to run extensive application validation testing and confirm the motor brake life span when the motor is mounted vertically and the motor runs through high acceleration and deceleration.

*Note 1 kg.cm² = 1x10⁻⁴ kg.m² ** Backlash figure will increase with time

3.13 Radial load

When selecting a motor some consideration must be made to the loading that the required application will put on the motor shaft. All shaft loads are transferred to the motor's bearing system, so a poorly selected motor could result in premature bearing failure.

Maximum axial and radial load

The following graphs show the Unimotor in terms of bearing strength. It has to be noted that the graphs are based on theoretical calculation, and that the bearing life of the motor is affected by the following:

- Speed
- Radial load applied to the bearings
- Axial load applied to the bearings
- Shock and vibration (external shock/vibration applied to the motor)
- Bearing temperature
- Bearing cleanliness
- Motor mounting to the application

The loads in the following graphs have been calculated using ISO 281 calculation L10(h). The loads and speeds used are considered to be constant throughout the life of the bearing.

The following factors have been taken into consideration when calculating the loads:

- 90 % reliability
- Radial load applied on the output shaft away from the shoulder and constant. The distance can be read on the different graphs
- Axial load going toward the motor and constant
- Load factor of 1: no vibration applied to the motor
- Temperature of the bearing: 100 °C max
- Grease clean

3.13.1 Radial load Unimotor fm

Radial load vs. axial load on 75U3/E3

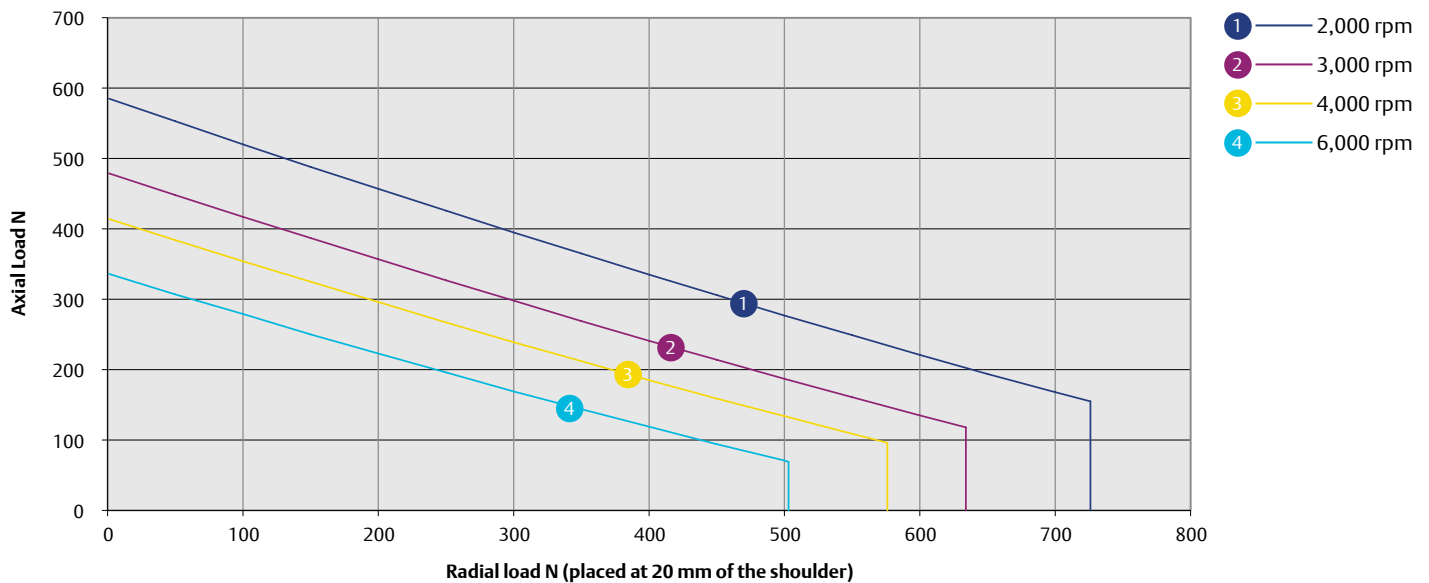

75U3/E3 $L_{10(h)}$ Bearing life for 20,000 hours (reliability 90 %, load factor of 1). Do not exceed a maximum axial load of 900 N. Axial loads exceeding that shown on the graph are permissible but the bearing life will be reduced below 20,000 hrs if applied.

Radial load vs. axial load on 95U3/E3

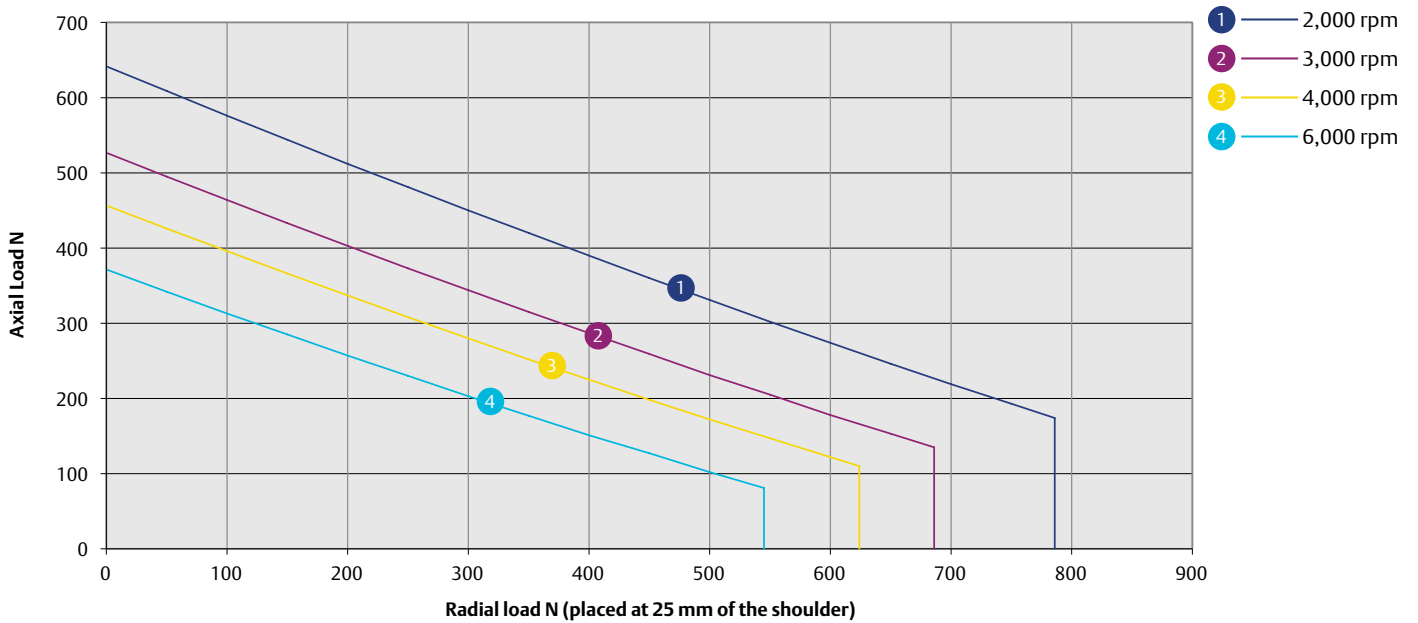

95U3/E3 $L_{10(h)}$ Bearing life for 20,000 hours (reliability 90 %, load factor of 1). Do not exceed a maximum axial load of 850 N
 Axial loads exceeding that shown on the graph are permissible but the bearing life will be reduced below 20,000 hrs if applied

Radial load vs. axial load on 115U3/E3

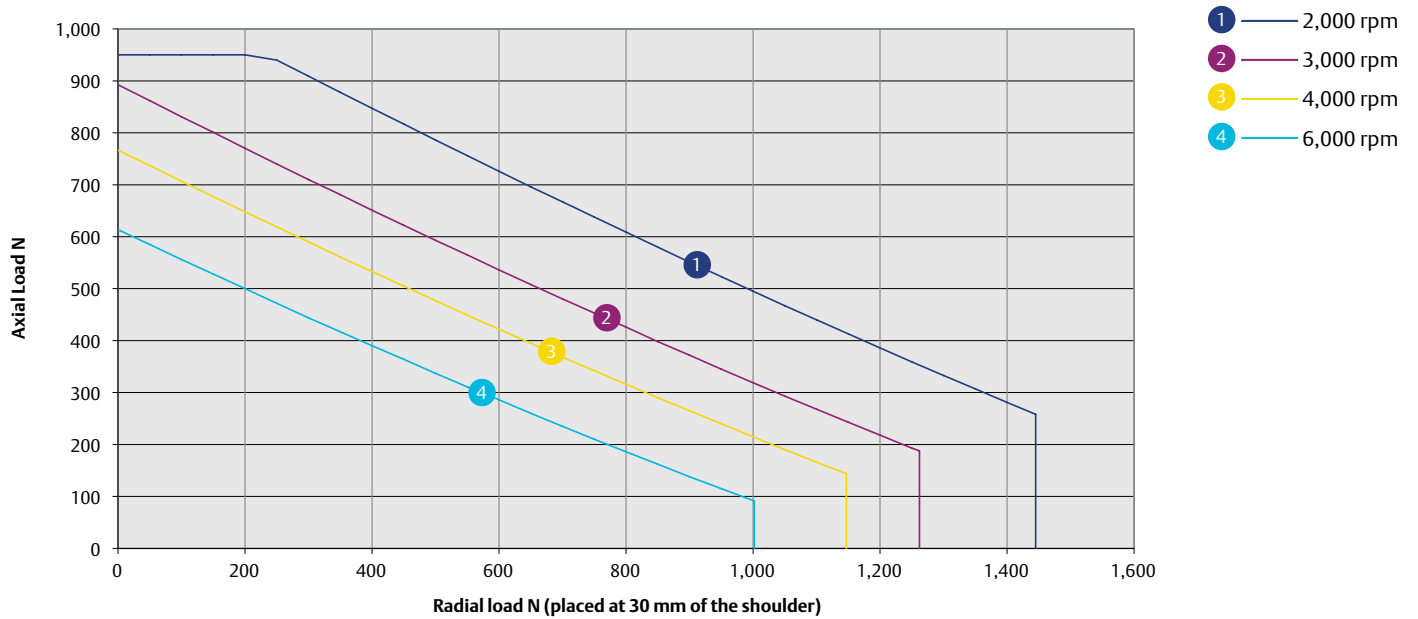

115U3/E3 $L_{10(h)}$ Bearing life for 20,000 hours (reliability 90 %, load factor of 1). Do not exceed a maximum axial load of 950 N
 Axial loads exceeding that shown on the graph are permissible but the bearing life will be reduced below 20,000 hrs if applied

Radial load vs. axial load on 142U3/E3

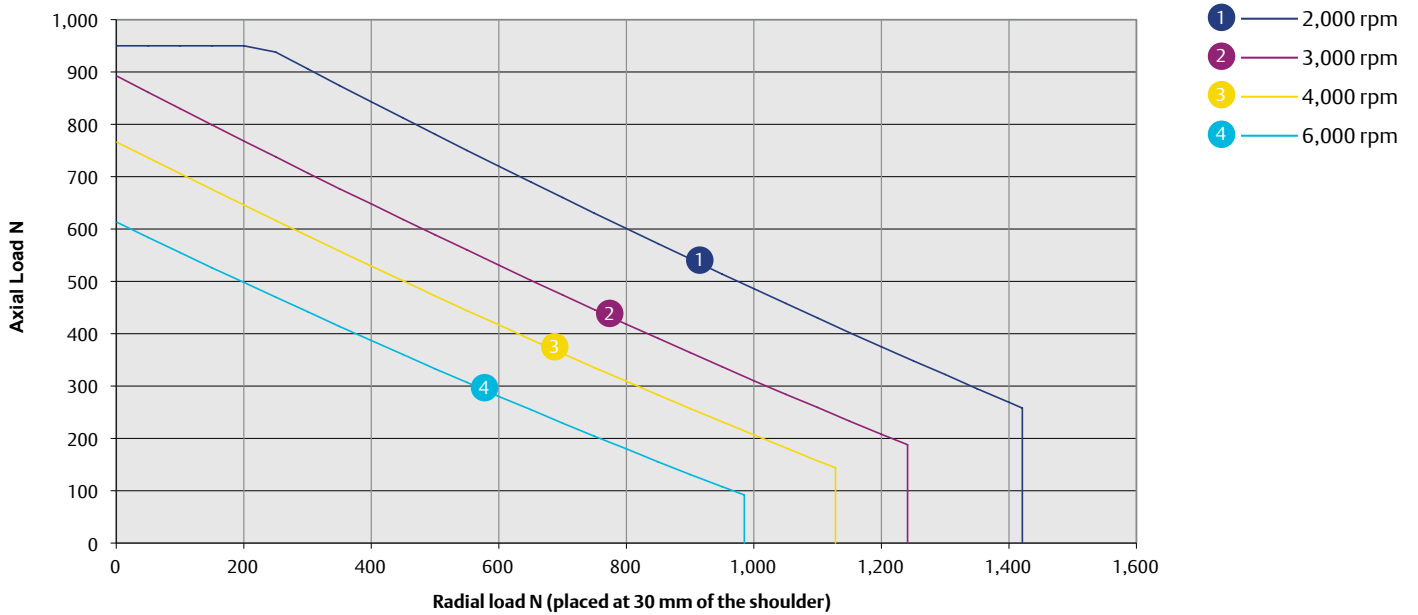

142U3/E3 $L_{10(h)}$ Bearing life for 20,000 hours (reliability 90 %, load factor of 1). Do not exceed a maximum axial load of 950 N
 Axial loads exceeding that shown on the graph are permissible but the bearing life will be reduced below 20,000 hrs if applied

Radial load vs. axial load on 190U3/E3

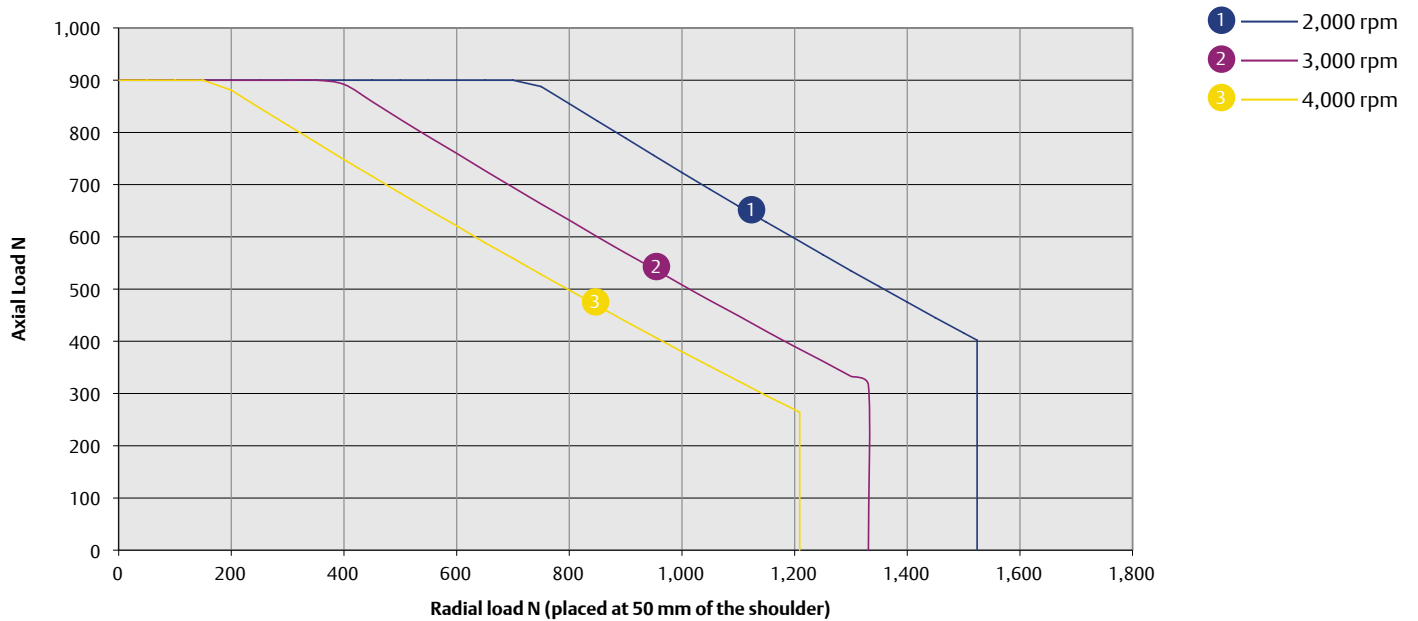

190U3/E3 $L_{10(h)}$ Bearing life for 20,000 hours (reliability 90 %, load factor of 1). Do not exceed a maximum axial load of 900 N
 Axial loads exceeding that shown on the graph are permissible but the bearing life will be reduced below 20,000 hrs if applied

Radial load vs. axial load on 250U3

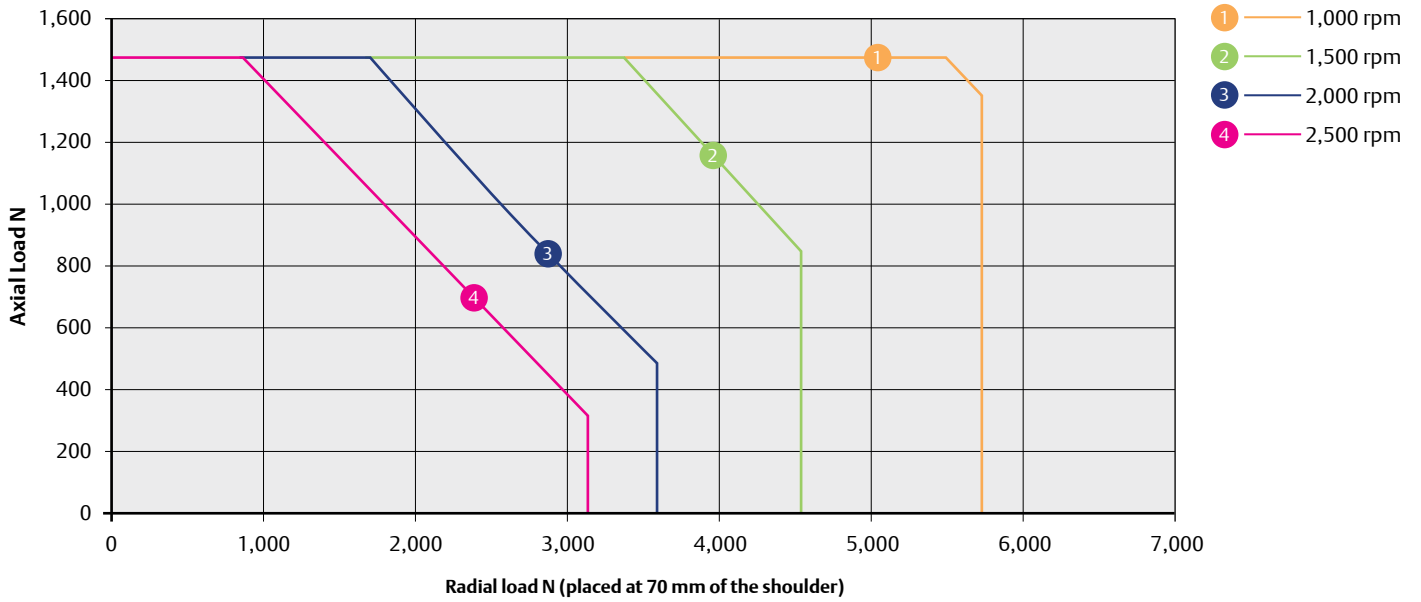

250U3 $L_{10(h)}$ Bearing life for 20,000 hours (reliability 90 %, load factor of 1). Do not exceed a maximum axial load of 1,450 N
 Axial loads exceeding that shown on the graph are permissible but the bearing life will be reduced below 20,000 hrs if applied

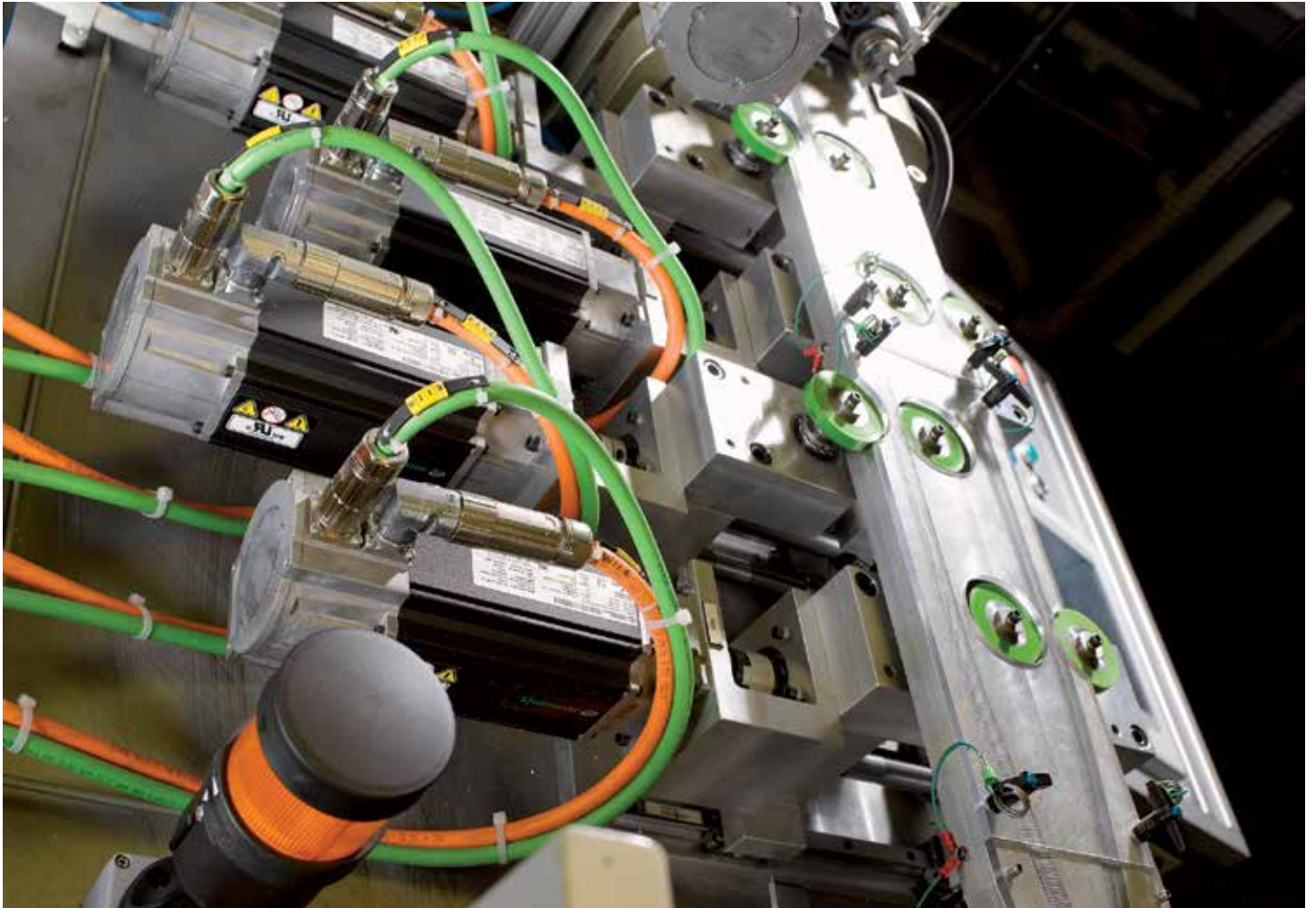

3.13.2 Unimotor hd

Radial load vs. axial load on 055UD/ED

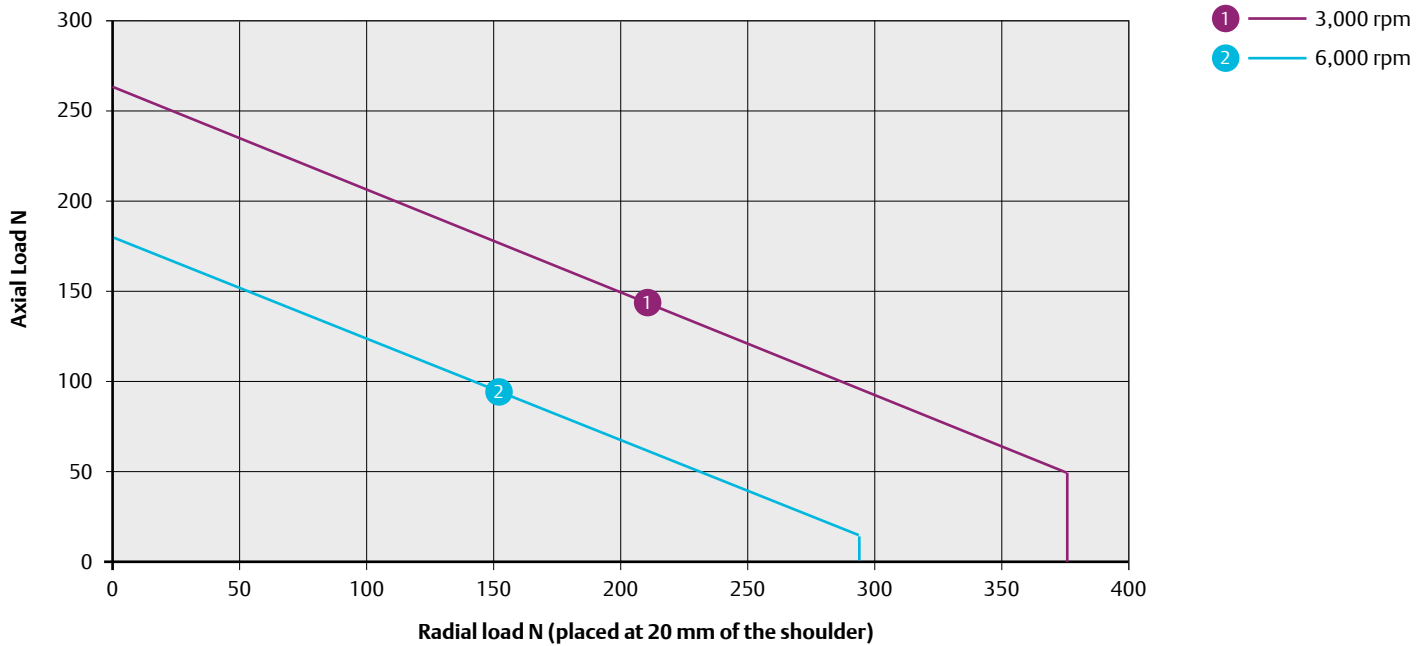

055UD/ED $L_{10(h)}$ Bearing life for 20,000 hours (reliability 90 %, load factor of 1). Do not exceed a maximum axial load of 650 N
Axial loads exceeding that shown on the graph are permissible but the bearing life will be reduced below 20,000 hrs if applied

Radial load vs. axial load on 067UD/ED

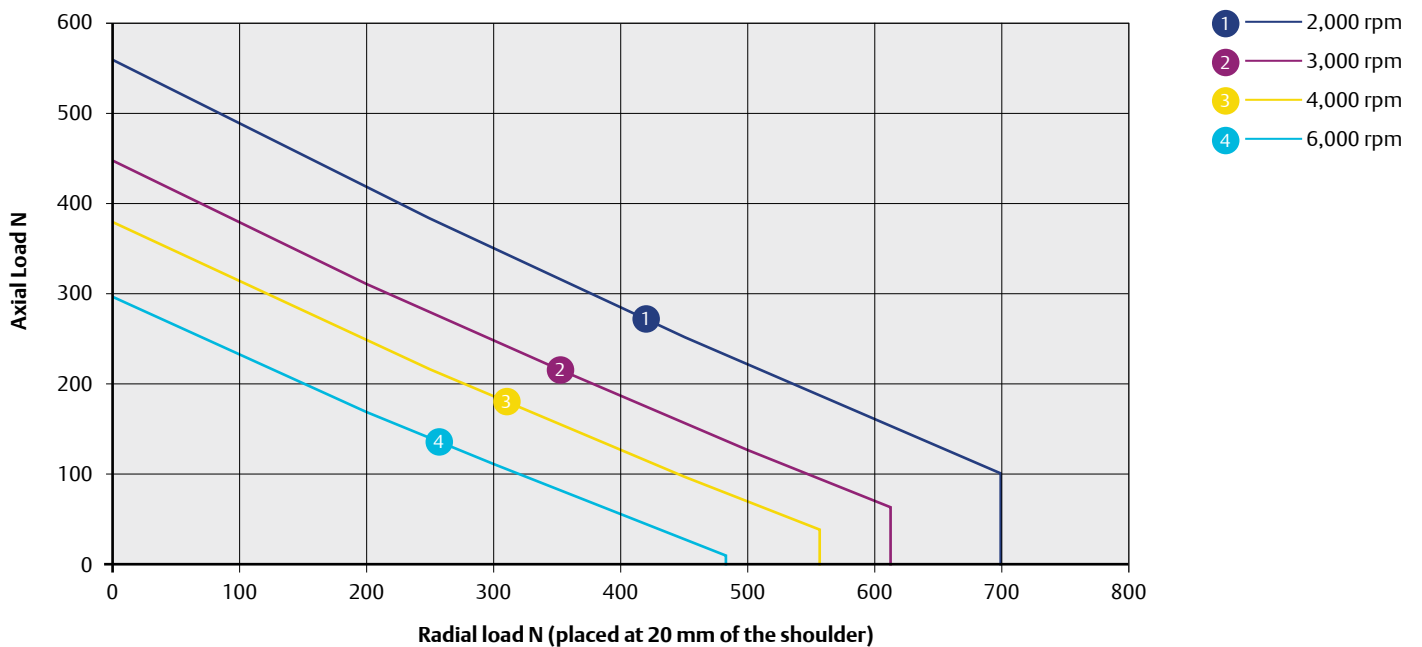

067UD/ED $L_{10(h)}$ Bearing life for 20,000 hours (reliability 90 %, load factor of 1). Do not exceed a maximum axial load of 650 N
Axial loads exceeding that shown on the graph are permissible but the bearing life will be reduced below 20,000 hrs if applied

Radial load vs. axial load on 089UD/ED

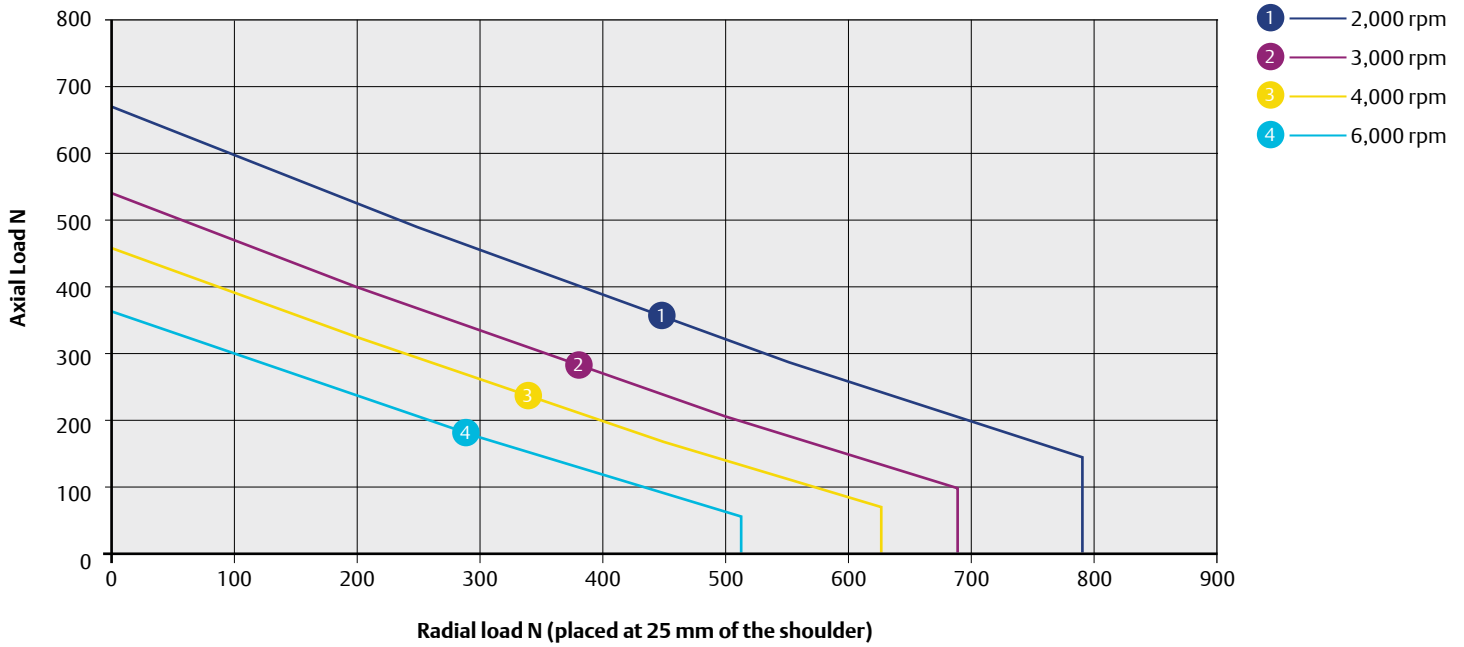

089UD/ED $L_{10(h)}$ Bearing life for 20,000 hours (reliability 90 %, load factor of 1). Do not exceed a maximum axial load of 1,000 N. Axial loads exceeding that shown on the graph are permissible but the bearing life will be reduced below 20,000 hrs if applied.

Radial load vs. axial load on 115UD/ED

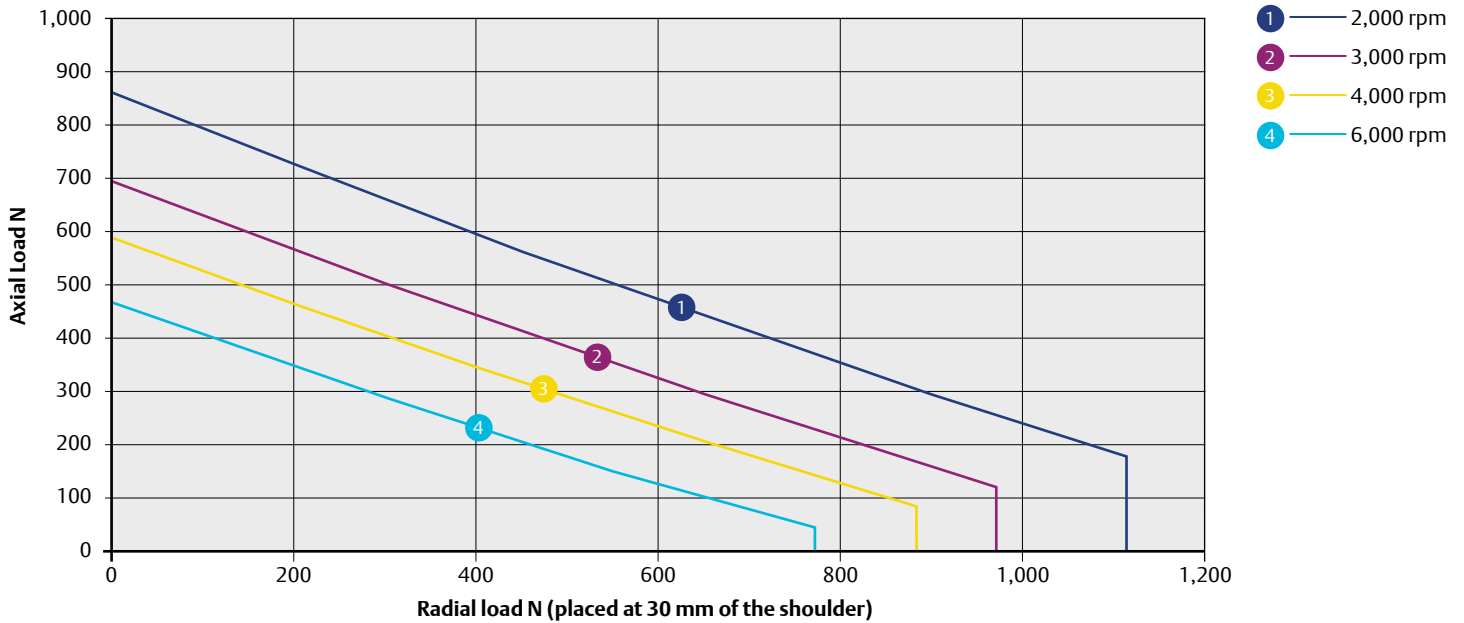

115UD/ED $L_{10(h)}$ Bearing life for 20,000 hours (reliability 90 %, load factor of 1). Do not exceed a maximum axial load of 1,200 N. Axial loads exceeding that shown on the graph are permissible but the bearing life will be reduced below 20,000 hrs if applied.

It can be seen on some graphs that the curve line becomes horizontal. This is due to the axial pushing load on the shaft (see *Shaft push back load*). This limit should not be exceeded in case the shaft moves.

Radial load vs. axial load on 142UD/ED

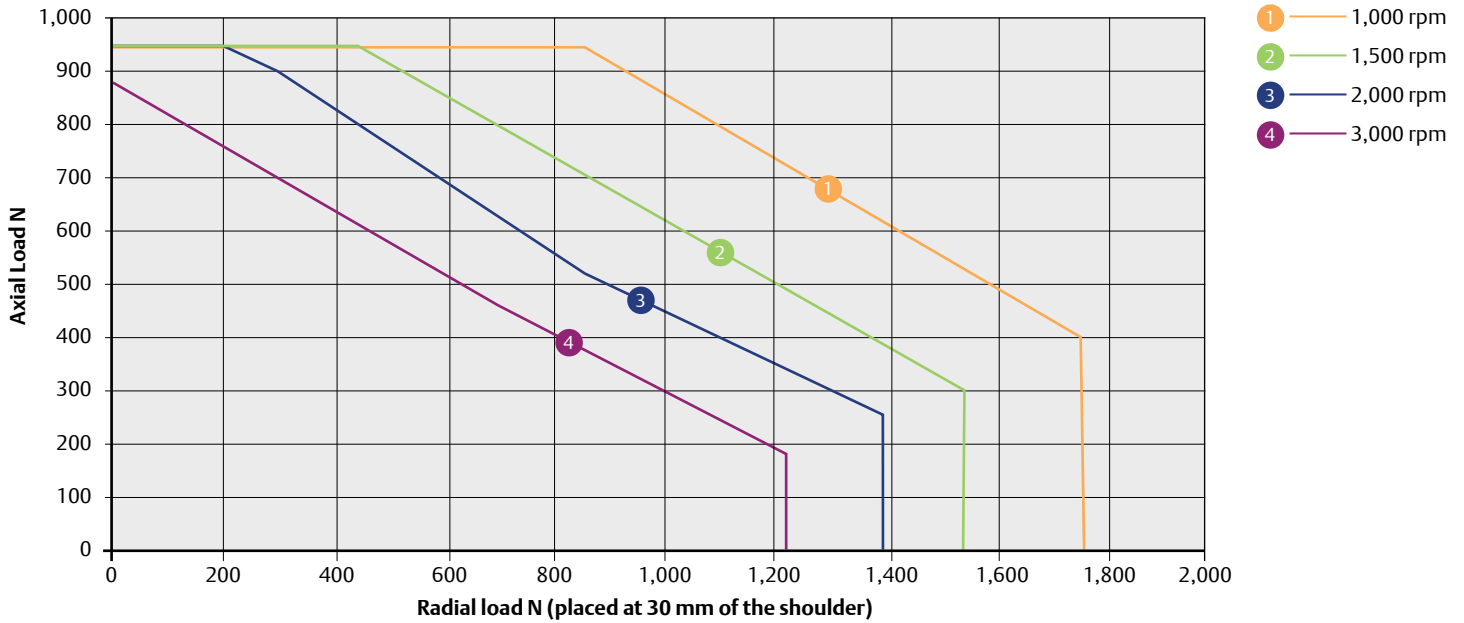

142UD/ED $L_{10(h)}$ Bearing life for 20,000 hours (reliability 90 %, load factor of 1). Do not exceed a maximum axial load of 950 N. Axial loads exceeding that shown on the graph are permissible but the bearing life will be reduced below 20,000 hrs if applied.

Radial load vs. axial load on 190UD/ED

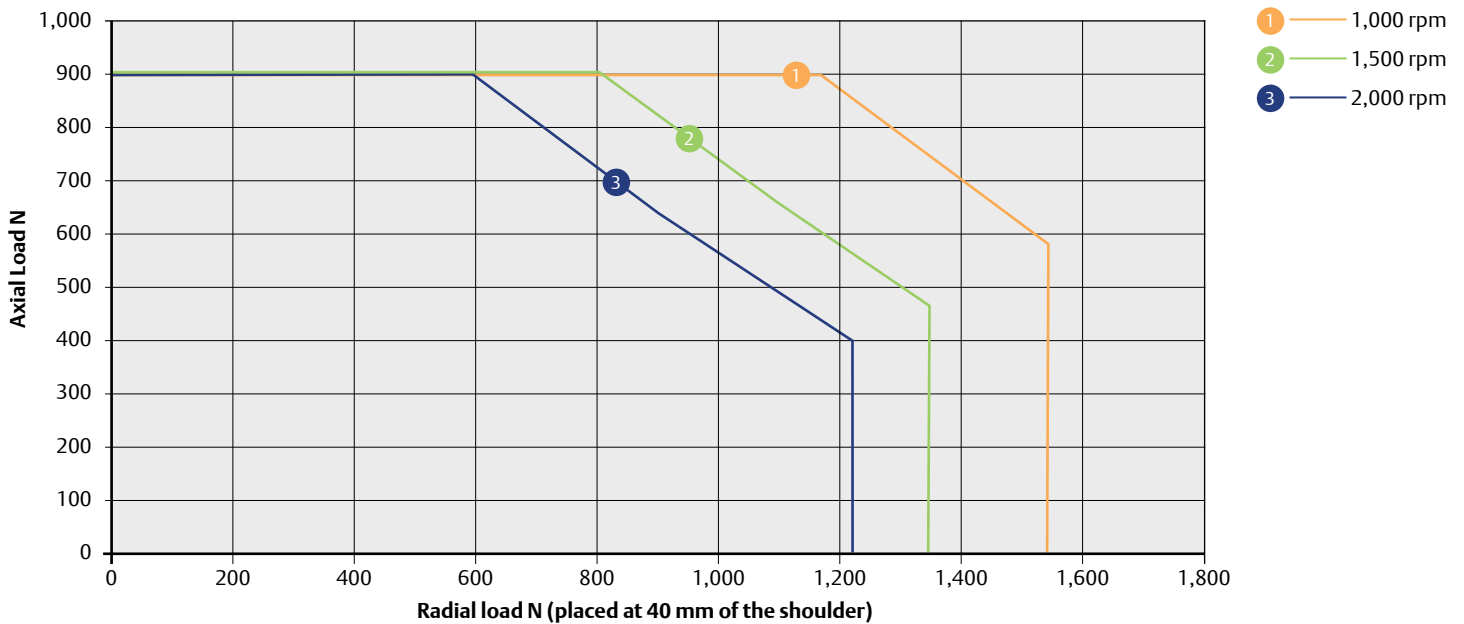

3.14 Bearing life and output shaft strength

The maximum output shaft that can be machined on the motor is determined by the inner diameter of the bearings. The bearing sizes on Unimotor fm motors have increased in comparison with the Unimotor UMs and this allows a larger output shaft to be machined. Larger output shafts mean stronger output shafts.

The following graphs show this improvement.

Maximum Bearing life

Please note: the graphs are based on theoretical calculations and the motor is affected by the following.

- Speed
- Radial load applied to the bearings
- Axial load applied to the bearings
- Shock and vibration
(external shock/vibration applied to the motor)
- Bearing temperature
- Bearing cleanliness
- Motor mounting to the application

The loads in the following graphs have been theoretically calculated. The following factors were taken into consideration:

- 90 % reliability (for bearing life only)
- Radial load applied on the output shaft away from the shoulder and constant. The distance can be read on the different graphs.
- Axial loads going towards the motor and constant (Axial load = 0 Nm)
- Load factor of 1 - no vibration applied to the motor (for bearing life only).
- Temperature of the bearing: 100 °C max.
- Grease clean (for bearing life only).
- Torque alternating (for shaft strength only).



3.14.1 Unimotor fm

Bearing life and output shaft strength on 75U3/E3

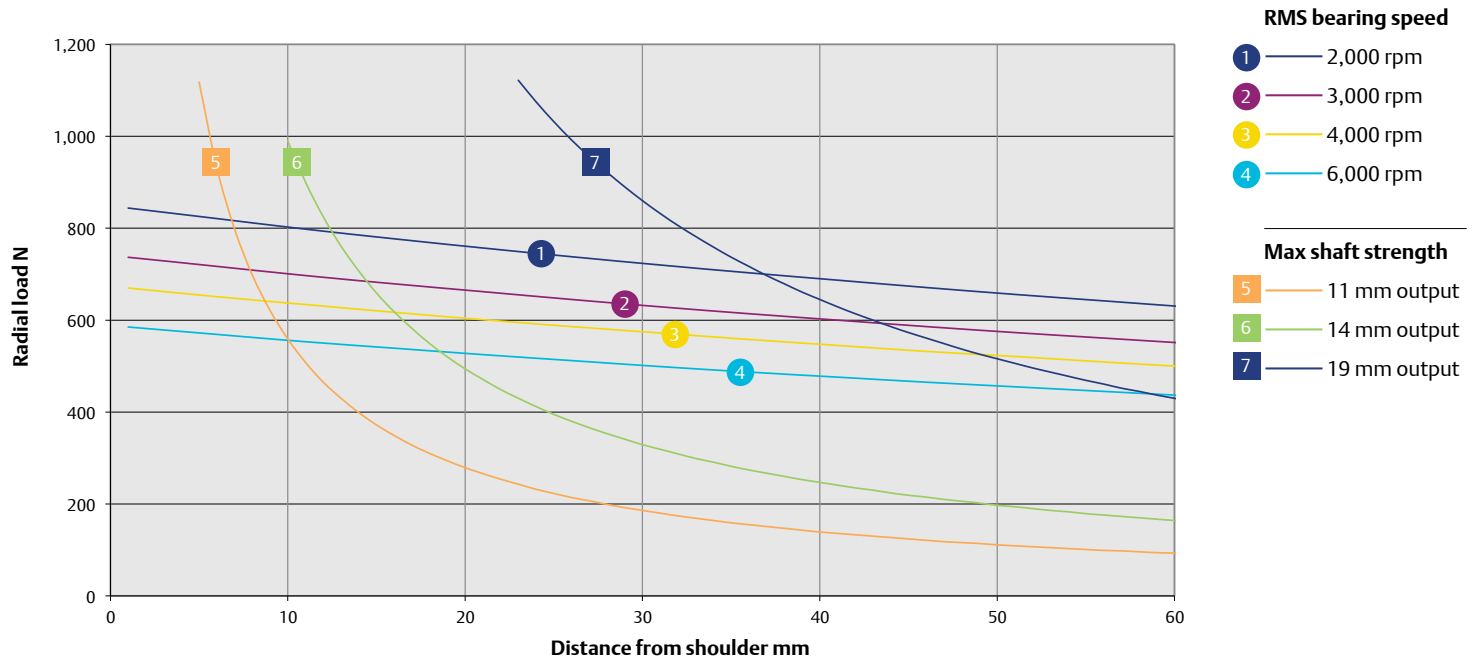

75U3/E3 $L_{10(h)}$ Bearing life and output shaft strength (20,000 hours, 90% reliability, load factor of 1)

Bearing life and output shaft strength on 95U3/E3

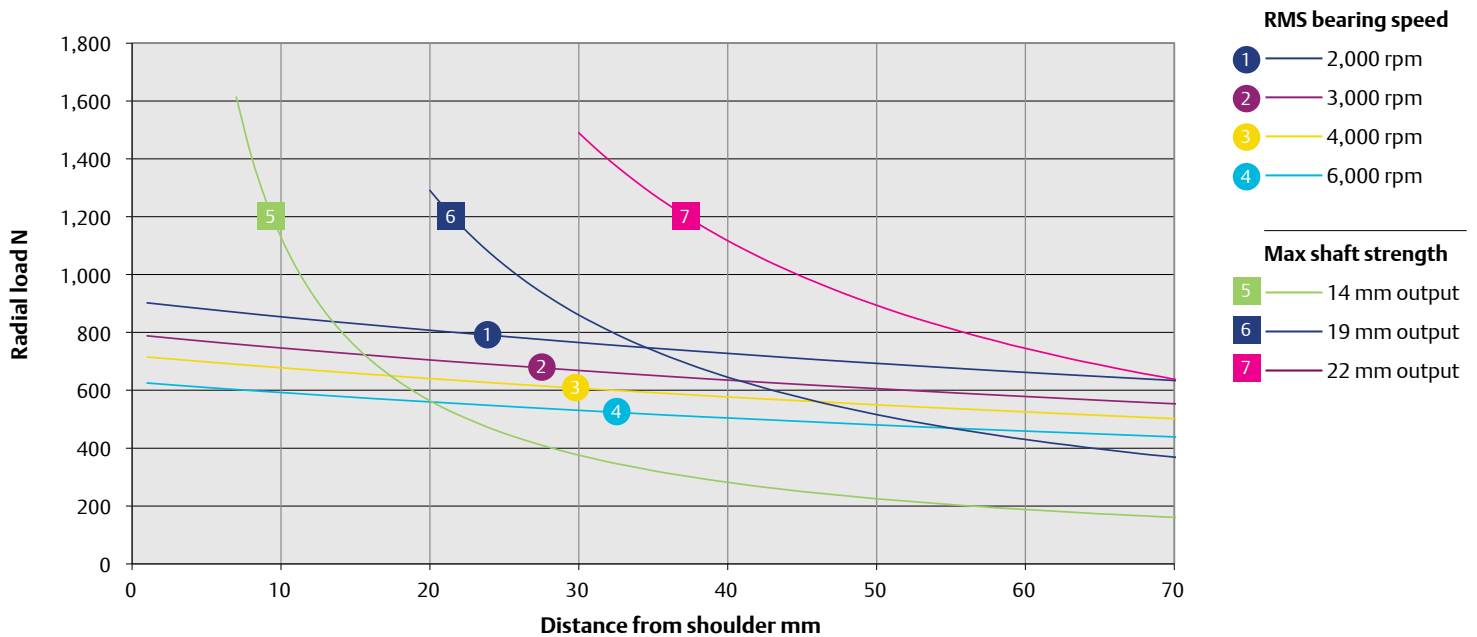

95U3/E3 $L_{10(h)}$ Bearing life and output shaft strength (20,000 hours, 90% reliability, load factor of 1)

Bearing life and output shaft strength on 115U3/E3

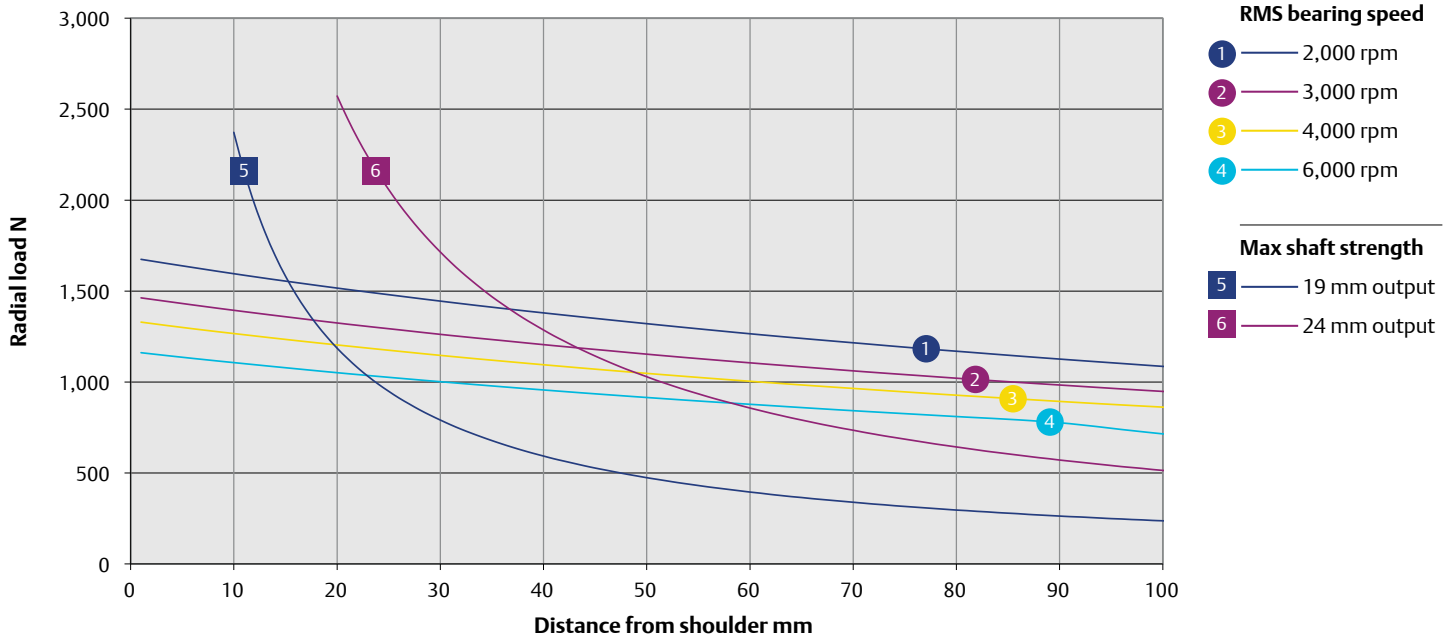

115U3/E3 $L_{10(h)}$ Bearing life and output shaft strength (20,000 hours, 90% reliability, load factor of 1)

Bearing life and output shaft strength on 142U3/E3

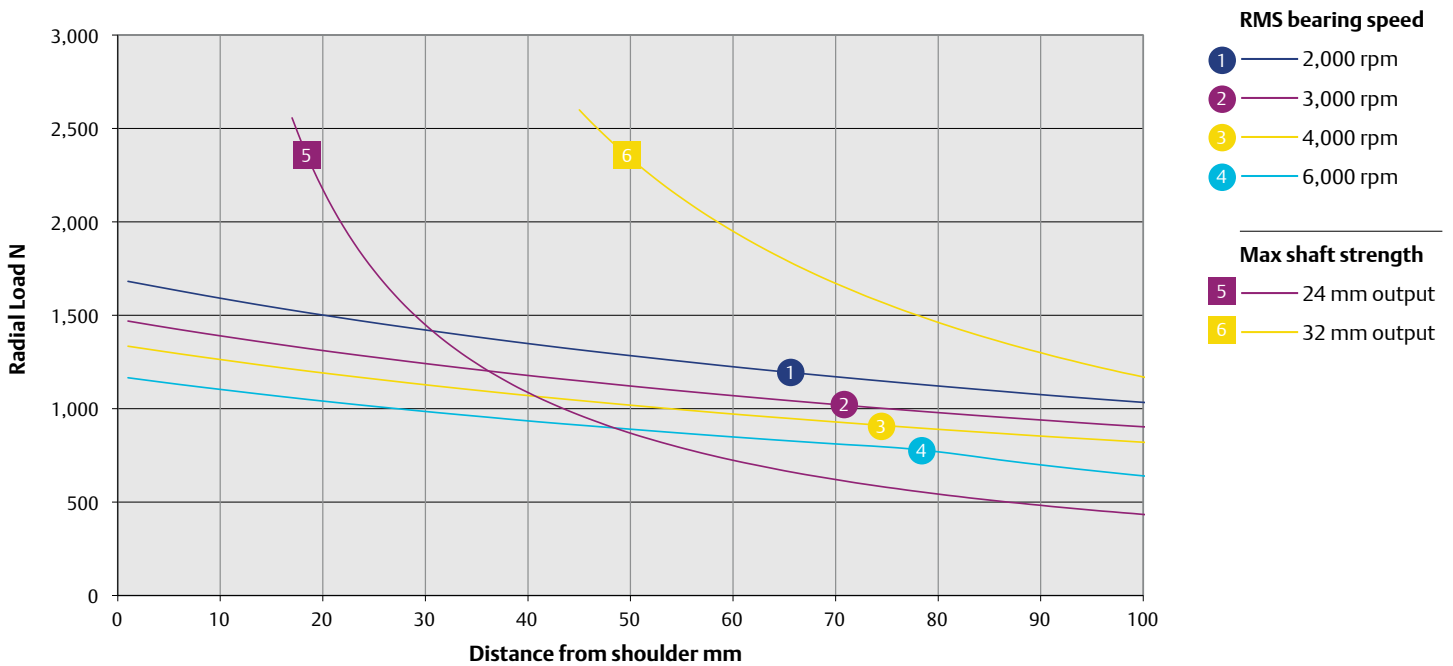

142U3/E3 $L_{10(h)}$ Bearing life for 20,000 hours (reliability 90%, load factor of 1)

Bearing life and output shaft strength on 190U3/E3

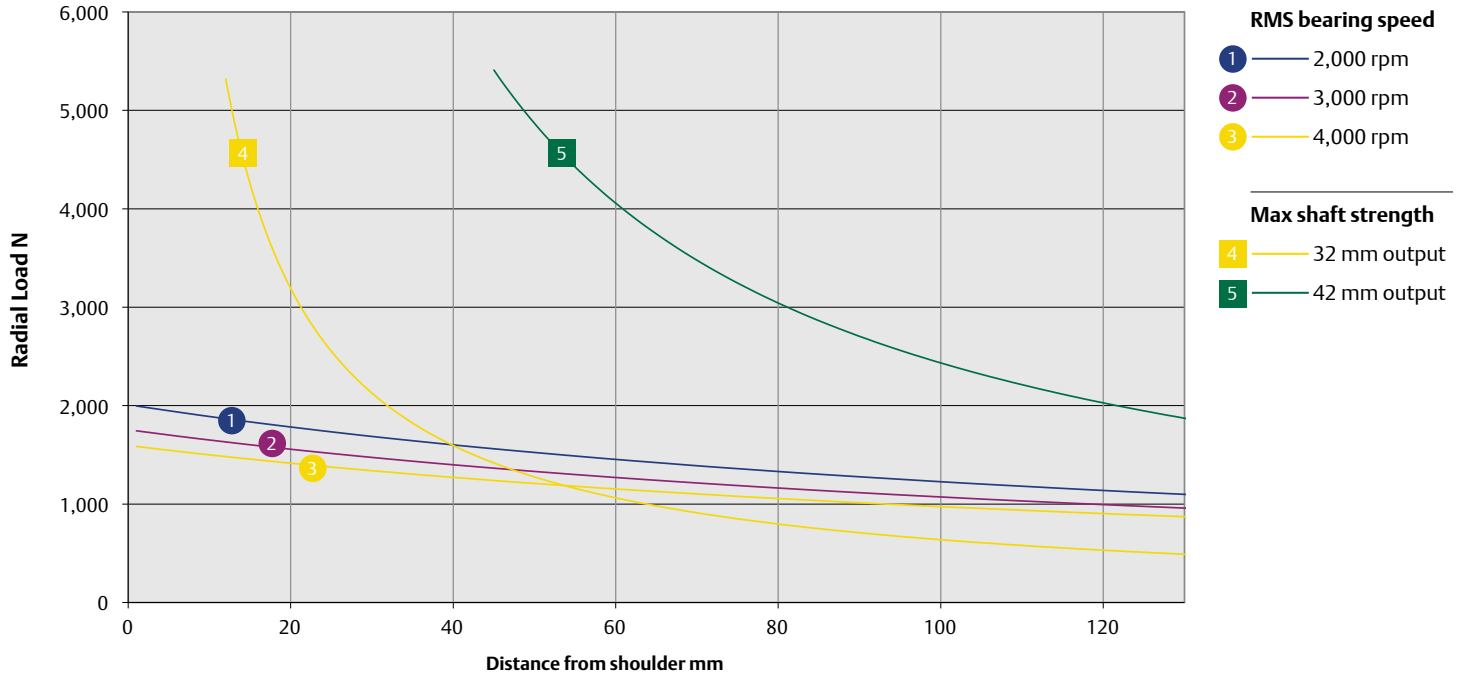

190U3/E3 $L_{10(h)}$ Bearing life for 20,000 hours (reliability 90 %, load factor of 1)

Bearing life and output shaft strength on 250U3/E3

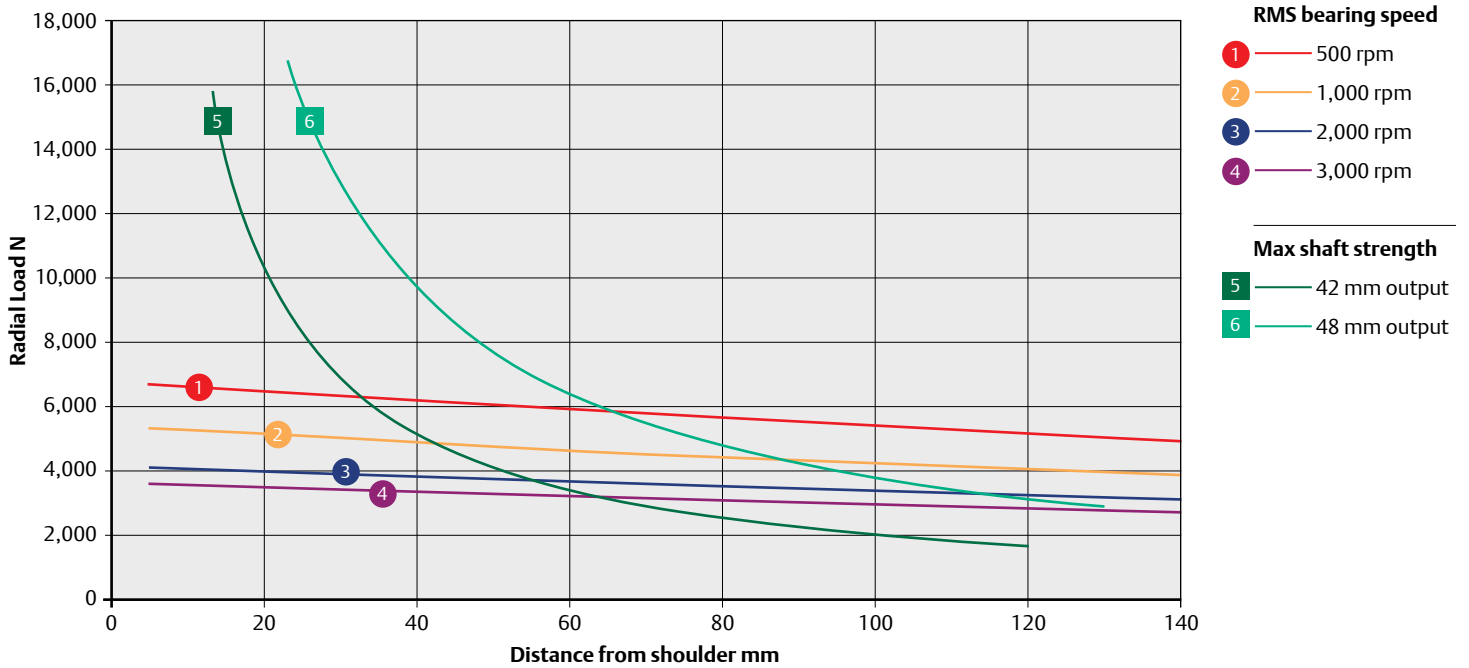

250U3/E3 $L_{10(h)}$ Bearing life for 20,000 hours (reliability 90 %, load factor of 1)

3.14.2 Unimotor hd

Bearing life and output shaft strength on 055UD/ED

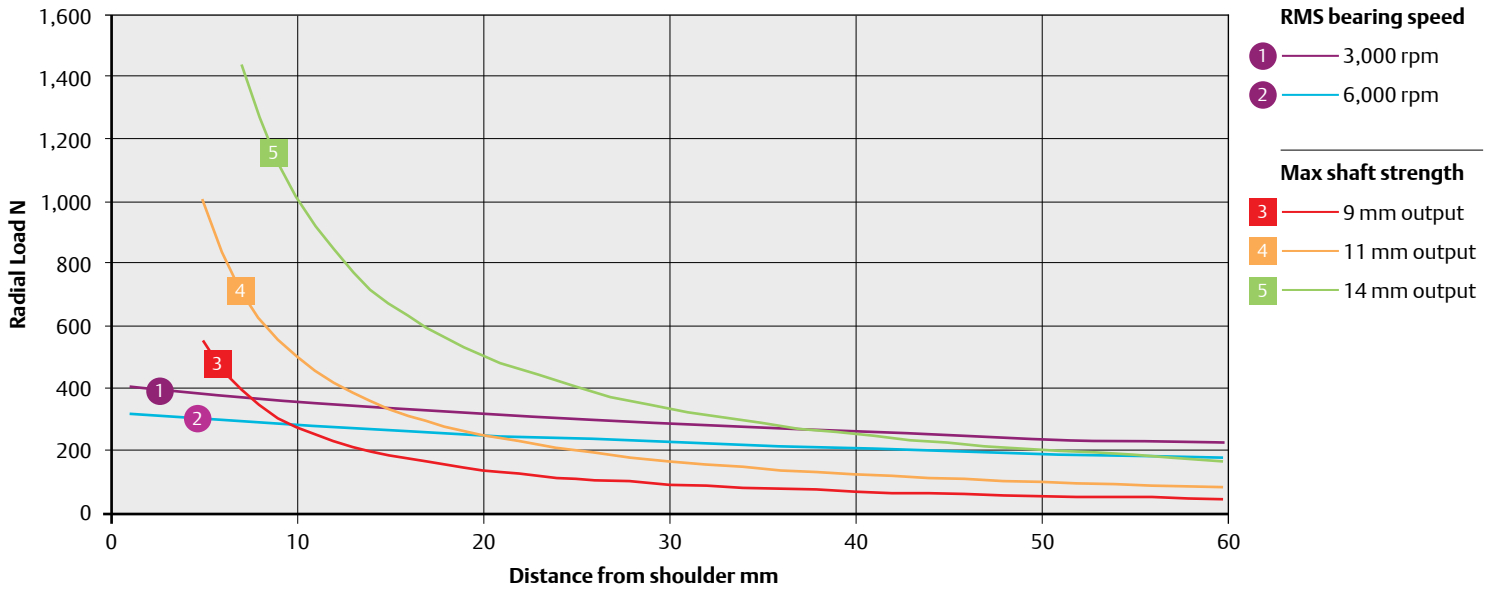

055UD/ED $L_{10(h)}$ Bearing life for 20,000 hours (reliability 90 %, load factor of 1). Do not exceed a maximum axial load of 450 N

Bearing life and output shaft strength on 067UD/ED

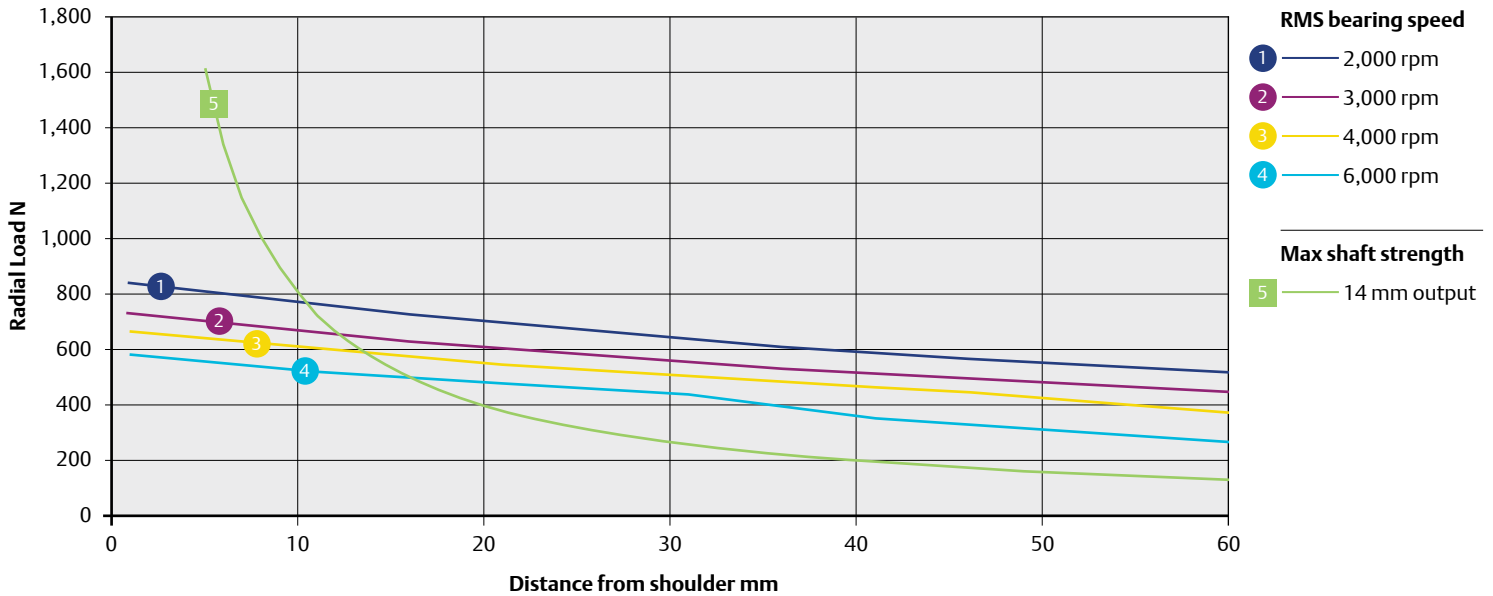

067UD/ED $L_{10(h)}$ Bearing life for 20,000 hours (reliability 90 %, load factor of 1).

Bearing life and output shaft strength on 089UD/ED

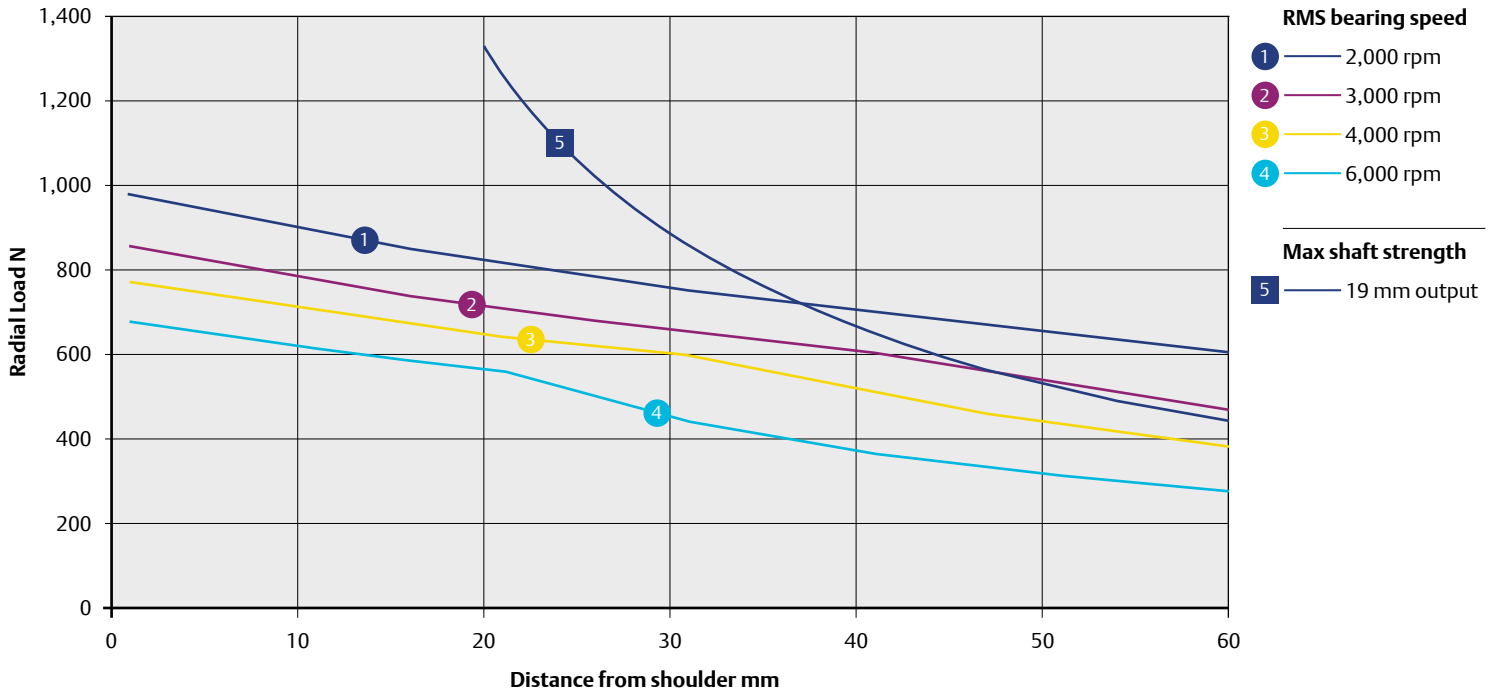

089UD/ED L_{10(h)} Bearing life for 20,000 hours (reliability 90 %, load factor of 1).

Bearing life and output shaft strength on 115UD/ED

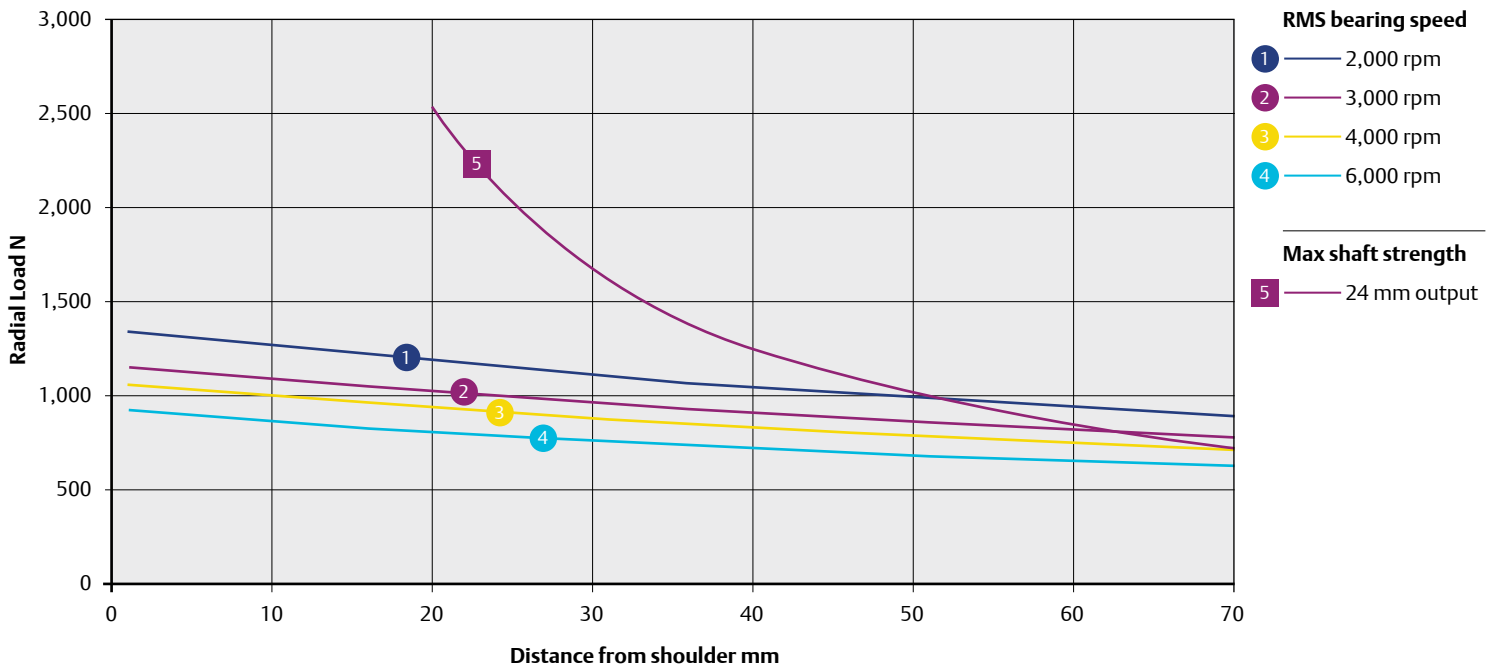

115UD/ED L_{10(h)} bearing life for 20,000 hours (reliability 90 %, load factor of 1).

Bearing life and output shaft strength on 142UD/ED

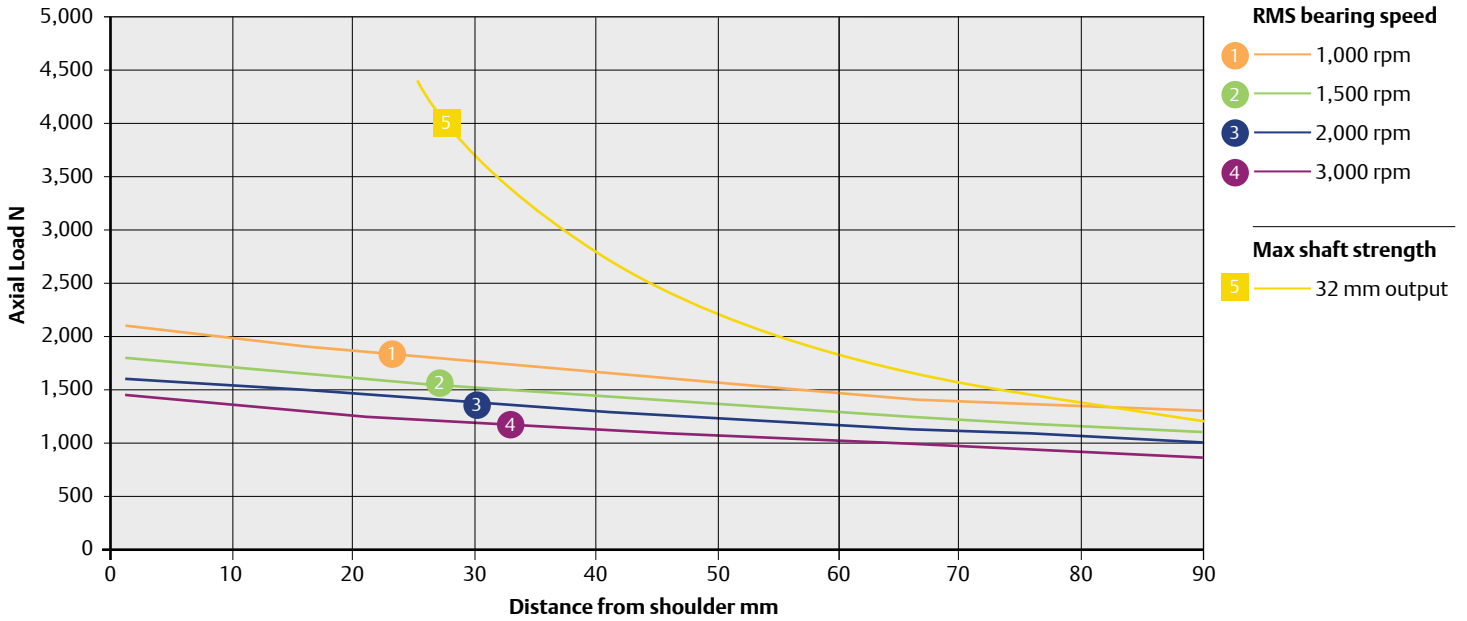

142UD/ED $L_{10(h)}$ Bearing life for 20,000 hours (reliability 90 %, load factor of 1).

Bearing life and output shaft strength on 190UD/ED

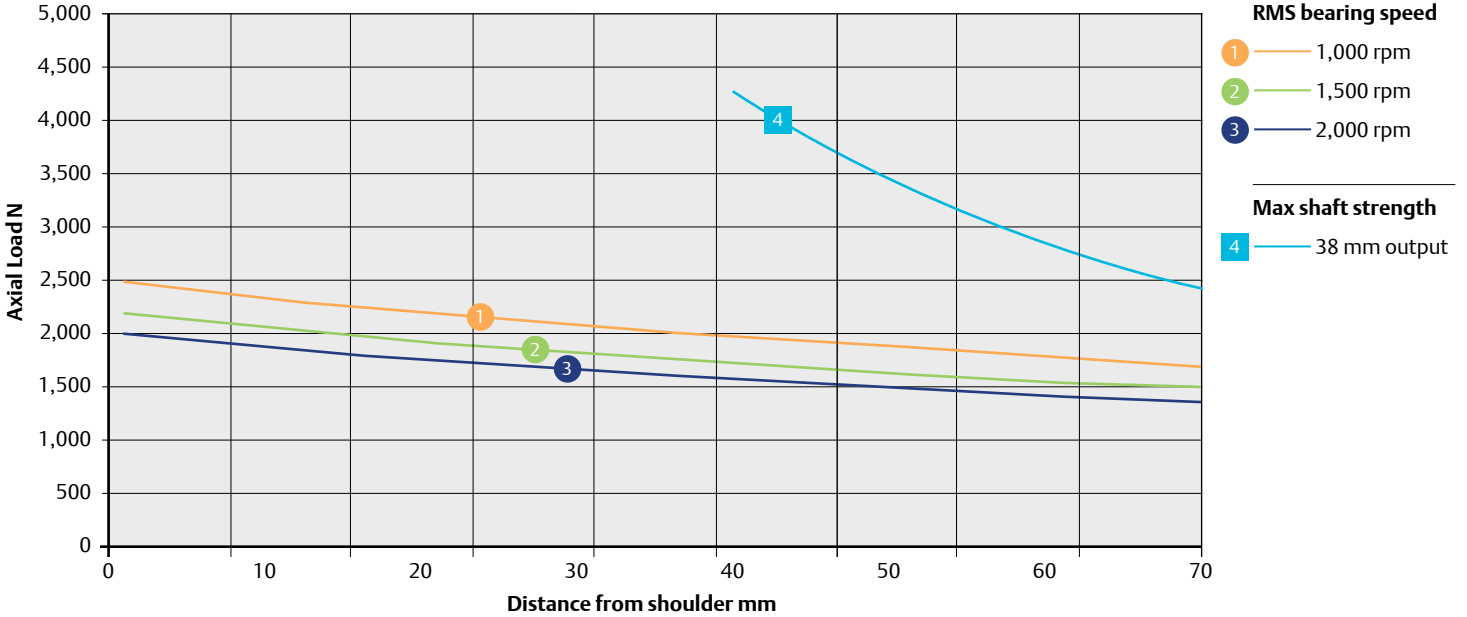

190UD/ED $L_{10(h)}$ Bearing life for 20,000 hours (reliability 90 %, load factor of 1).

Shaft push back load

The minimum pushing load needed to move the rotor relative to the bearings.

The table (right) shows the minimum push back force on Unimotor.

Motor	Push back force (N)	Motor	Push back force (N)
Unimotor fm		Unimotor hd	
075	900	055	190
095	850	067	650
115	950	089	1,000
142	950	115	1,200
190	900	142	1,350
250	1,450	190	1,600

4 Performance graphs

The torque speed graph depicts the limits of operation for a given motor. The limits of operation are shown for three categories.

Torque/speed graph

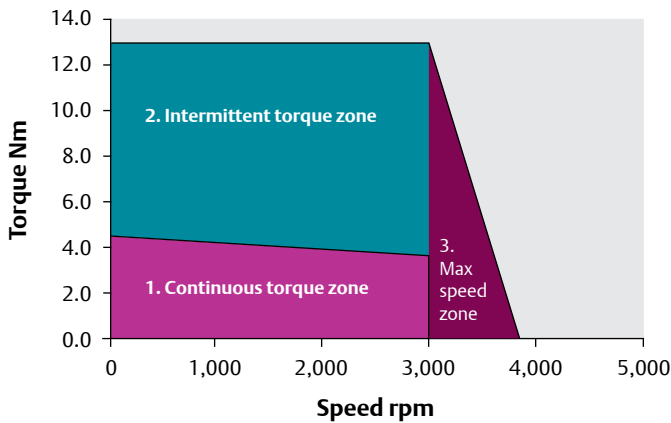

1. Continuous or rms torque zone

This area gives the effective continuous or rms torque available for repetitive torque sequences. Continuous or rms torque must be within this area otherwise the motor may overheat and cause the system to trip out.

2. Intermittent or peak torque zone

Above the continuous zone is the intermittent zone where the motor may be safely operated for short periods of time. Operation within the intermittent zone is permissible provided that the defined peak torque limit is not exceeded. On some frame sizes the peak torque factor of 3 x stall current only applies up to a certain percentage level of rms current before it starts to reduce.

Please refer to the *Standard (2) peak torque* section for details.

Maximum peak torque is the upper limit of the intermittent zone and must never be exceeded, to do so will damage the motor.

3. Maximum speed zone

To the right of the graph is a sloping line depicting the maximum motor speed when using a 200 V/400 V drive supply. The speed limit line is dependent upon the motor windings, and the voltage supplied to the drive. Operation within the maximum speed zone is permissible as long as the maximum speed limit is not exceeded. If the speed is increased beyond the limit shown, the motors sinusoidal waveform would have insufficient voltage and will clip and distort, causing inefficiency and higher temperature. If the distortion increases further, the drive may lose control of the motor and trip.

Plotting an operating point

To estimate whether a motor is the correct choice for a given system, it is necessary to calculate or measure the rms torque and the rms speed for a given system in its normal continual stop/start sequenced mode. These operating points may be plotted on the torque speed graph. As shown in the first graph below, if the rms

speed and torque point lies well within the continuous zone, then the motor is suitable for the application. The second graph below shows the max speed has increased to 3,900 rpm and this is now outside the safe area and another speed motor must be selected.

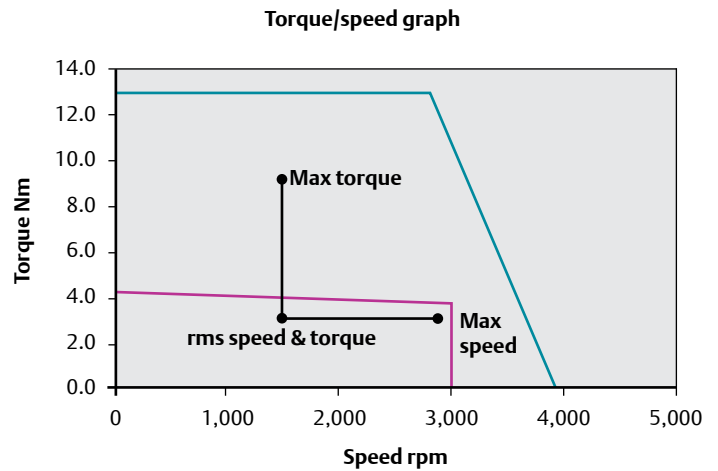

Max torque = 10 Nm: Max speed = 2,900 rms torque = 3 Nm: rms speed = 1,500

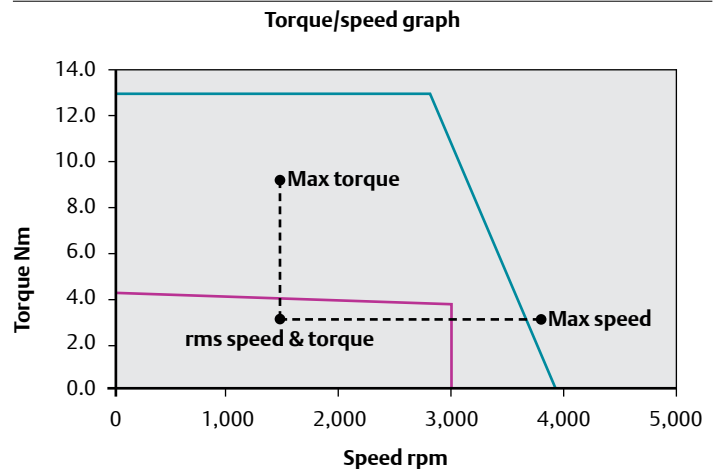

Max torque = 10 Nm: Max speed = 3,900 rms torque = 3 Nm: rms speed = 1,500

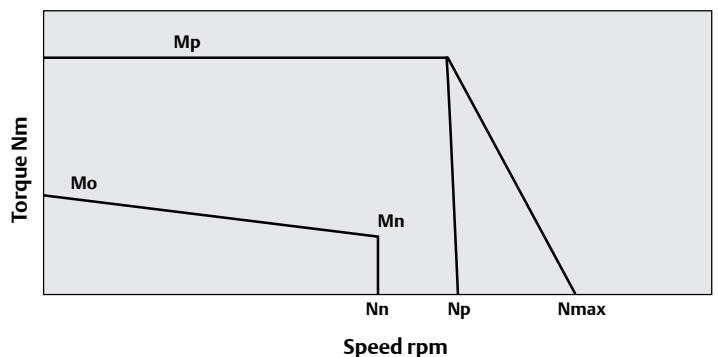

Mn = continuous torque at the rated speed: Nn = rated speed:
Np = maximum speed at the peak torque: Mo = stall torque:
Mp = peak torque: Nmax = maximum speed with no torque

Performance graph data

hd 400 V	Nn [rpm]	Mo [Nm]	Mn [Nm]	Mp [Nm]	Np [rpm]	Nmax [rpm]
HD055UDA30	3000	0.72	0.7	2.88	4569	8444
HD055UDA60	6000	0.72	0.68	2.88	4569	8444
HD055UDB30	3000	1.18	1.05	4.72	2306	4222
HD055UDB60	6000	1.18	0.9	4.72	5607	8000
HD055UDC30	3000	1.65	1.48	6.6	2327	3800
HD055UDC60	6000	1.65	1.2	6.6	5321	7600
HD067UDA30	3000	1.45	1.4	4.35	3569	7755
HD067UDA60	6000	1.45	1.3	4.35	3569	7755
HD067UDB30	3000	2.55	2.45	7.65	2176	3877
HD067UDB60	6000	2.55	2.2	7.65	4797	7755
HD067UDC30	3000	3.7	3.5	11.1	2083	3877
HD067UDC60	6000	3.7	3.1	11.1	4590	7755
HD089UDA30	3000	3.2	3	9.6	1760	3877
HD089UDA40	4000	3.2	2.9	9.6	2244	5170
HD089UDA60	6000	3.2	2.65	9.6	3750	7755
HD089UDB30	3000	5.5	4.85	16.5	1795	3877
HD089UDB40	4000	5.5	4.55	16.5	2704	5170
HD089UDB60	6000	5.5	3.8	16.5	3743	7755
HD089UDC30	3000	8	6.9	24	2082	3877
HD089UDC40	4000	8	6.35	24	2546	5170
HD089UDC60	6000	8	5	24	3726	7755
HD115UDB20	2000	10.2	8.6	30.6	1277	2585
HD115UDB30	3000	10.2	7.7	30.6	2109	3877
HD115UDC20	2000	14.6	11.9	43.8	1445	2585
HD115UDC30	3000	14.6	10.5	43.8	2027	3877
HD115UDD20	2000	18.8	15.6	56.4	1445	2585
HD115UDD30	3000	18.8	13.6	56.4	2232	3877
HD142UDC15	1500	25	22.3	74.9	1242	1938
HD142UDC20	2000	25	21.4	74.9	1674	2585
HD142UDC30	3000	25	18.4	74.9	2581	3877
HD142UDD15	1500	31.5	27	94.5	1329	1938
HD142UDD20	2000	31.5	25.7	94.5	1674	2585
HD142UDD30	3000	31.5	20.9	94.5	2743	3877
HD142UDE15	1500	38	31.7	114	1346	1938
HD142UDE20	2000	38	29.6	114	1641	2585
HD142UDE30	3000	38	23	114	2781	3877
HD190UDC15	1500	52	46.2	156	1028	1938
HD190UDC20	2000	52	42.5	156	1361	2585
HD190UDD15	1500	62	52.2	186	1135	1938
HD190UDF15	1500	85	68.5	255	1224	1938

fm 400 V	Nn [rpm]	Mo [Nm]	Mn [Nm]	Mp [Nm]	Np [rpm]	Nmax [rpm]
FM075U3A20	2000	1.44	1.3	4.32	371	2585
FM075U3A30	3000	1.44	1.3	4.32	1638	3877
FM075U3A40	4000	1.44	1.2	4.32	2539	5170
FM075U3A60	6000	1.44	1.1	4.32	4838	7755
FM075U3B20	2000	2.65	2.5	7.95	1102	2585
FM075U3B30	3000	2.65	2.3	7.95	2299	3877
FM075U3B40	4000	2.65	2.1	7.95	3367	5170
FM075U3B60	6000	2.65	1.9	7.95	5751	7755
FM075U3C20	2000	3.72	3.5	11.16	1413	2585
FM075U3C30	3000	3.72	3.3	11.16	2583	3877
FM075U3C40	4000	3.72	2.8	11.16	3827	5170
FM075U3C60	6000	3.72	2.8	11.16	6142	7755
FM075U3D20	2000	4.67	4.5	14.01	1561	2585
FM075U3D30	3000	4.67	4.2	14.01	2847	3877
FM075U3D40	4000	4.67	3.8	14.01	3897	5170
FM075U3D60	6000	4.67	3.4	14.01	6248	7755
FM095U3A20	2000	2.45	2.4	7.35	902	2585
FM095U3A30	3000	2.45	2.3	7.35	2021	3877
FM095U3A40	4000	2.45	2.3	7.35	2929	5170
FM095U3A60	6000	2.45	2	7.35	4996	7755
FM095U3B20	2000	4.5	4.3	13.5	1418	2585
FM095U3B30	3000	4.5	4.1	13.5	2589	3877
FM095U3B40	4000	4.5	3.8	13.5	3550	5170
FM095U3B60	6000	4.5	3.2	13.5	5868	7755
FM095U3C20	2000	6.3	5.9	18.9	1740	2585
FM095U3C30	3000	6.3	5.6	18.9	2864	3877
FM095U3C40	4000	6.3	5.3	18.9	3973	5170
FM095U3C60	6000	6.3	4.2	18.9	6128	7755

fm 400 V	Nn [rpm]	Mo [Nm]	Mn [Nm]	Mp [Nm]	Np [rpm]	Nmax [rpm]
FM095U3D20	2000	7.9	7.3	23.7	1810	2585
FM095U3D30	3000	7.9	6.9	23.7	2982	3877
FM095U3D40	4000	7.9	6.4	23.7	4115	5170
FM095U3E20	2000	9.25	8.5	27.75	1948	2585
FM095U3E30	3000	9.25	8.2	27.75	3133	3877
FM095U3E40	4000	9.25	7.4	27.75	4211	5170
FM115U3A20	2000	3.9	3.7	11.7	1027	2585
FM115U3A30	3000	3.9	3.5	11.7	1994	3877
FM115U3A40	4000	3.9	3	11.7	2764	5170
FM115U3A60	6000	3.9	2.7	11.7	4701	7755
FM115U3B20	2000	7.4	7.3	22.2	1428	2585
FM115U3B30	3000	7.4	6.7	22.2	2502	3877
FM115U3B40	4000	7.4	5.8	22.2	3365	5170
FM115U3B60	6000	7.4	5	22.2	5421	7755
FM115U3C20	2000	10.8	10.1	32.4	1659	2585
FM115U3C30	3000	10.8	9.5	32.4	2701	3877
FM115U3C40	4000	10.8	7.5	32.4	3696	5170
FM115U3D20	2000	13.65	11.9	40.95	1717	2585
FM115U3D30	3000	13.65	11.2	40.95	2839	3877
FM115U3D40	4000	13.65	8.3	40.95	3948	5170
FM115U3E20	2000	16	14.1	48	1807	2585
FM115U3E30	3000	16	12.7	48	2854	3877
FM115U3E40	4000	16	8.8	48	3981	5170
FM142U3A20	2000	6.2	5.9	18.6	1162	2585
FM142U3A30	3000	6.2	5.5	18.6	2012	3877
FM142U3A40	4000	6.2	4.1	18.6	2780	5170
FM142U3A60	6000	6.2	3.2	18.6	4308	7755
FM142U3B20	2000	11	10.4	33	1567	2585
FM142U3B30	3000	11	9.5	33	2473	3877
FM142U3B40	4000	11	8.1	33	3429	5170
FM142U3B60	6000	11	5.2	33	5227	7755
FM142U3C20	2000	15.7	14.7	47.1	1749	2585
FM142U3C30	3000	15.7	12.8	47.1	2690	3877
FM142U3C40	4000	15.7	10.2	47.1	3657	5170
FM142U3D20	2000	20.5	18.5	61.5	1803	2585
FM142U3D30	3000	20.5	16	61.5	2769	3877
FM142U3D40	4000	20.5	12.2	61.5	3729	5170
FM142U3E20	2000	25	21.5	75	1874	2585
FM142U3E30	3000	25	18.2	75	2900	3877
FM142U3E40	4000	25	14	75	3836	5170
FM190U3A20	2000	11.25	10.8	33.75	1087	2585
FM190U3A30	3000	11.25	10.3	33.75	1761	3877
FM190U3A40	4000	11.25	8.2	33.75	2387	5170
FM190U3B20	2000	22.5	20.6	67.5	1304	2585
FM190U3B30	3000	22.5	19.4	67.5	2013	3877
FM190U3B40	4000	22.5	18.2	67.5	2675	5170
FM190U3C20	2000	33.5	29.4	100.5	1376	2585
FM190U3C30	3000	33.5	26.5	100.5	1972	3877
FM190U3C40	4000	33.5	23	100.5	2801	5170
FM190U3D20	2000	44.5	37.9	133.5	1633	2585
FM190U3D30	3000	44.5	33.2	133.5	2178	3877
FM190U3D40	4000	44.5	29	133.5	3146	5170
FM190U3E20	2000	54	44.3	162	1474	2585
FM190U3E30	3000	54	34.2	162	2243	3877
FM190U3F20	2000	63	50.5	189	1491	2585
FM190U3F30	3000	63	35.2	189	2123	3877
FM190U3G20	2000	71	54	213	1438	2585
FM190U3G30	3000	71	36.2	213	1950	3877
FM190U3H20	2000	77	56	231	1449	2585
FM190U3H30	3000	77	37	231	2439	3877
FM250U3D10	1000	92	75	276	697	1176
FM250U3D15	1500	92	67	276	1081	1759
FM250U3D20	2000	92	65	276	1447	2345
FM250U3D25	2500	92	62	276	1873	2945
FM250U3E10	1000	116	92	348	676	1176
FM250U3E15	1500	116	76	348	1029	1759
FM250U3E20	2000	116	73	348	1519	2345
FM250U3E25	2500	116	70	348	1743	2945
FM250U3F10	1000	136	106	408	723	1176
FM250U3F15	1500	136	84	408	1107	1759
FM250U3F20	2000	136	81	408	1493	2345
FM250U3F25	2500	136	77	408	1767	2945

hd 220 V	Nn [rpm]	Mo [Nm]	Mn [Nm]	Mp [Nm]	Np [rpm]	Nmax [rpm]
HD055EDA30	3000	0.72	0.7	2.88	1913	4644
HD055EDA60	6000	0.72	0.68	2.88	4649	7740
HD055EDB30	3000	1.18	1.05	4.72	2207	3980
HD055EDB60	6000	1.18	0.9	4.72	5403	8038
HD055EDC30	3000	1.65	1.48	6.6	2320	3800
HD055EDC60	6000	1.65	1.2	6.6	5237	7206
HD067EDA30	3000	1.45	1.4	4.35	1395	3666
HD067EDA60	6000	1.45	1.3	4.35	3547	7333
HD067EDB30	3000	2.55	2.45	7.65	2138	3666
HD067EDB60	6000	2.55	2.2	7.65	4725	7333
HD067EDC30	3000	3.7	3.5	11.1	2052	3666
HD089EDA30	3000	3.2	3	9.6	1703	3666
HD089EDA40	4000	3.2	2.9	9.6	2161	4888
HD089EDA60	6000	3.2	2.65	9.6	3226	7333
HD089EDB30	3000	5.5	4.85	16.5	1800	3666
HD089EDB40	4000	5.5	4.55	16.5	2669	4888
HD089EDB60	6000	5.5	3.8	16.5	3789	7333
HD089EDC30	3000	8	6.9	24	2007	3666
HD089EDC40	4000	8	6.35	24	2592	4888
HD089EDC60	6000	8	5	24	3700	7333
HD115EDB20	2000	10.2	8.6	30.6	1274	2444
HD115EDB30	3000	10.2	7.7	30.6	2072	3666
HD115EDC20	2000	14.6	11.9	43.8	1423	2444
HD115EDC30	3000	14.6	10.5	43.8	2006	3666
HD115EDD20	2000	18.8	15.6	56.4	1354	2444
HD142EDC10	1000	25	23.3	74.9	616	1222
HD142EDC20	2000	25	21.4	74.9	1327	2444
HD142EDC30	3000	25	18.4	74.9	2357	3666
HD142EDD10	1000	31.5	29	94.5	668	1222
HD142EDD20	2000	31.5	25.7	94.5	1436	2444
HD142EDD30	3000	31.5	20.9	94.5	2297	3666
HD142EDE10	1000	38	34.5	114	686	1222
HD142EDE20	2000	38	29.6	114	1467	2444
HD190EDC10	1000	52	49	156	568	1222
HD190EDC20	2000	52	42.5	156	1193	2444
HD190EDD10	1000	62	56.5	186	565	1222
HD190EDF10	1000	85	77.5	255	622	1222

fm 220 V	Nn [rpm]	Mo [Nm]	Mn [Nm]	Mp [Nm]	Np [rpm]	Nmax [rpm]
FM075E3A20	2000	1.44	1.3	4.32	283	2444
FM075E3A30	3000	1.44	1.3	4.32	1503	3666
FM075E3A40	4000	1.44	1.2	4.32	2316	4888
FM075E3A60	6000	1.44	1.1	4.32	4438	7333
FM075E3B20	2000	2.65	2.5	7.95	992	2444
FM075E3B30	3000	2.65	2.3	7.95	2172	3666
FM075E3B40	4000	2.65	2.1	7.95	3224	4888
FM075E3B60	6000	2.65	1.9	7.95	5354	7333
FM075E3C20	2000	3.72	3.5	11.16	1339	2444
FM075E3C30	3000	3.72	3.3	11.16	2533	3666
FM075E3C40	4000	3.72	2.8	11.16	3543	4888
FM075E3C60	6000	3.72	2.8	11.16	5685	7333
FM075E3D20	2000	4.67	4.5	14.01	1488	2444
FM075E3D30	3000	4.67	4.2	14.01	2617	3666
FM075E3D40	4000	4.67	3.8	14.01	3726	4888
FM075E3D60	6000	4.67	3.4	14.01	5976	7333
FM095E3A20	2000	2.45	2.4	7.35	779	2444
FM095E3A30	3000	2.45	2.3	7.35	1764	3666
FM095E3A40	4000	2.45	2.3	7.35	2717	4888
FM095E3A60	6000	2.45	2	7.35	4621	7333
FM095E3B20	2000	4.5	4.3	13.5	1324	2444
FM095E3B30	3000	4.5	4.1	13.5	2397	3666
FM095E3B40	4000	4.5	3.8	13.5	3349	4888
FM095E3B60	6000	4.5	3.2	13.5	5525	7333
FM095E3C20	2000	6.3	5.9	18.9	1560	2444
FM095E3C30	3000	6.3	5.6	18.9	2641	3666
FM095E3C40	4000	6.3	5.3	18.9	3518	4888
FM095E3C60	6000	6.3	4.2	18.9	5690	7333

fm 220 V	Nn [rpm]	Mo [Nm]	Mn [Nm]	Mp [Nm]	Np [rpm]	Nmax [rpm]
FM095E3D20	2000	7.9	7.3	23.7	1721	2444
FM095E3D30	3000	7.9	6.9	23.7	2816	3666
FM095E3D40	4000	7.9	6.4	23.7	3798	4888
FM095E3E20	2000	9.25	8.5	27.75	1763	2444
FM095E3E30	3000	9.25	8.2	27.75	2859	3666
FM095E3E40	4000	9.25	7.4	27.75	3962	4888
FM115E3A20	2000	3.9	3.7	11.7	875	2444
FM115E3A30	3000	3.9	3.5	11.7	1791	3666
FM115E3A40	4000	3.9	3	11.7	2448	4888
FM115E3A60	6000	3.9	2.7	11.7	3777	7333
FM115E3B20	2000	7.4	7.3	22.2	1373	2444
FM115E3B30	3000	7.4	6.7	22.2	2299	3666
FM115E3B40	4000	7.4	5.8	22.2	3115	4888
FM115E3B60	6000	7.4	5	22.2	4888	7333
FM115E3C20	2000	10.8	10.1	32.4	1535	2444
FM115E3C30	3000	10.8	9.5	32.4	2491	3666
FM115E3C40	4000	10.8	7.5	32.4	3420	4888
FM115E3D20	2000	13.65	11.9	40.95	1436	2444
FM115E3D30	3000	13.65	11.2	40.95	2525	3666
FM115E3D40	4000	13.65	8.3	40.95	3627	4888
FM115E3E20	2000	16	14.1	48	1540	2444
FM115E3E30	3000	16	12.7	48	2652	3666
FM115E3E40	4000	16	8.8	48	3423	4888
FM142E3A20	2000	6.2	5.9	18.6	999	2444
FM142E3A30	3000	6.2	5.5	18.6	1841	3666
FM142E3A40	4000	6.2	4.1	18.6	2574	4888
FM142E3A60	6000	6.2	3.2	18.6	4147	7333
FM142E3B20	2000	11	10.4	33	1477	2444
FM142E3B30	3000	11	9.5	33	2369	3666
FM142E3B40	4000	11	8.1	33	3312	4888
FM142E3C20	2000	15.7	14.7	47.1	1634	2444
FM142E3C30	3000	15.7	12.8	47.1	2591	3666
FM142E3C40	4000	15.7	10.2	47.1	3298	4888
FM142E3D20	2000	20.5	18.5	61.5	1731	2444
FM142E3D30	3000	20.5	16	61.5	2477	3666
FM142E3D40	4000	20.5	12.2	61.5	3287	4888
FM142E3E20	2000	25	21.5	75	1730	2444
FM142E3E30	3000	25	18.2	75	2752	3666
FM142E3E40	4000	25	14	75	3807	4888
FM190E3A20	2000	11.25	10.8	33.75	1067	2444
FM190E3A30	3000	11.25	10.3	33.75	1670	3666
FM190E3A40	4000	11.25	8.2	33.75	2345	4888
FM190E3B20	2000	22.5	20.6	67.5	1256	2444
FM190E3B30	3000	22.5	19.4	67.5	1774	3666
FM190E3B40	4000	22.5	18.2	67.5	2414	4888
FM190E3C20	2000	33.5	29.4	100.5	1310	2444
FM190E3C30	3000	33.5	26.5	100.5	1876	3666
FM190E3C40	4000	33.5	23	100.5	2533	4888
FM190E3D20	2000	44.5	37.9	133.5	1449	2444
FM190E3D30	3000	44.5	33.2	133.5	1916	3666
FM190E3D40	4000	44.5	29	133.5	2700	4888
FM190E3E20	2000	54	44.3	162	1363	2444
FM190E3E30	3000	54	34.2	162	1867	3666
FM190E3F20	2000	63	50.5	189	1351	2444
FM190E3F30	3000	63	35.2	189	2062	3666
FM190E3G20	2000	71	54	213	1350	2444
FM190E3G30	3000	71	36.2	213	1682	3666
FM190E3H20	2000	77	56	231	1350	2444
FM190E3H30	3000	77	37	231	2201	3666

4.1 Unimotor fm

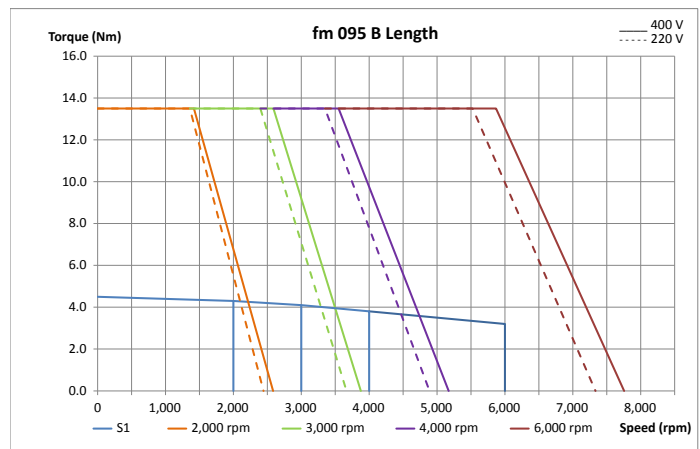
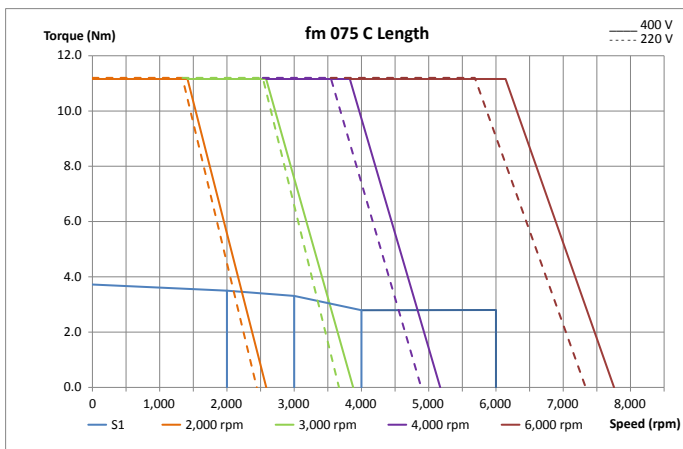
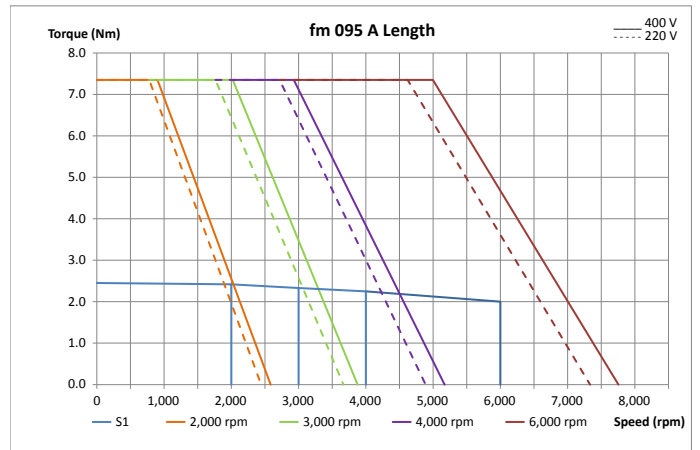
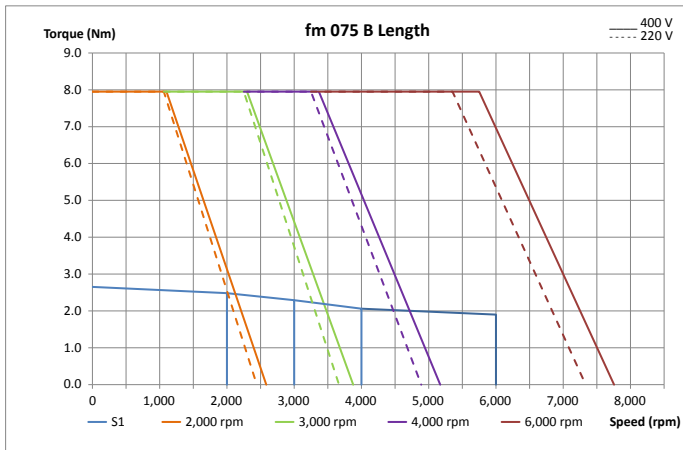
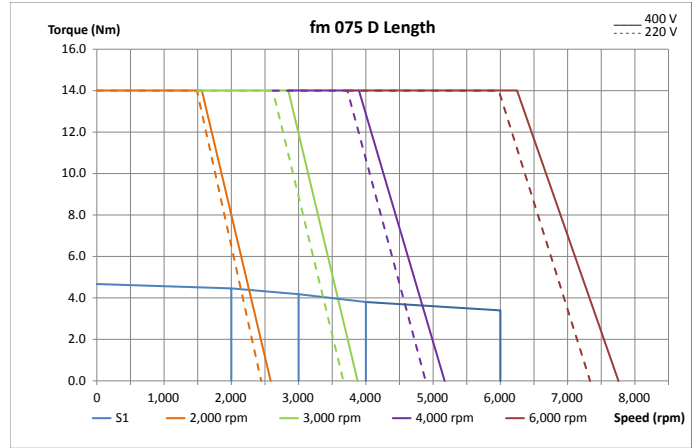
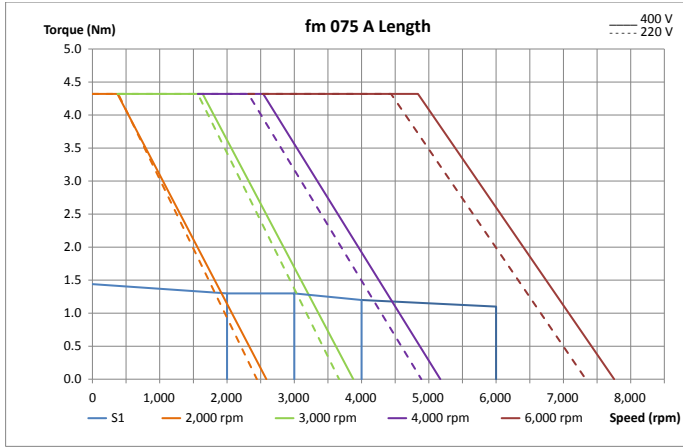

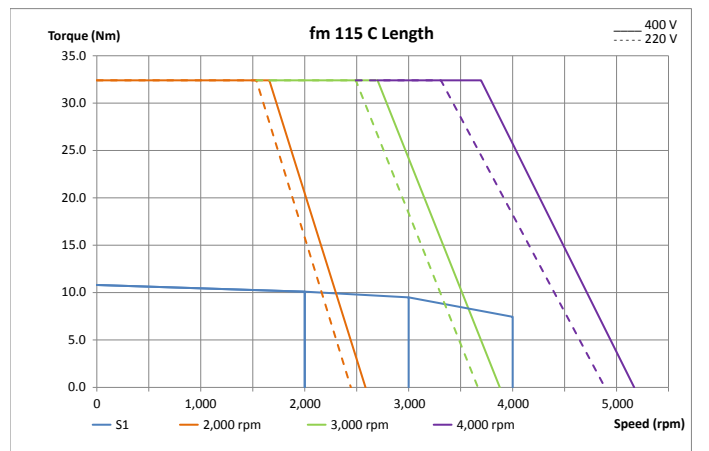
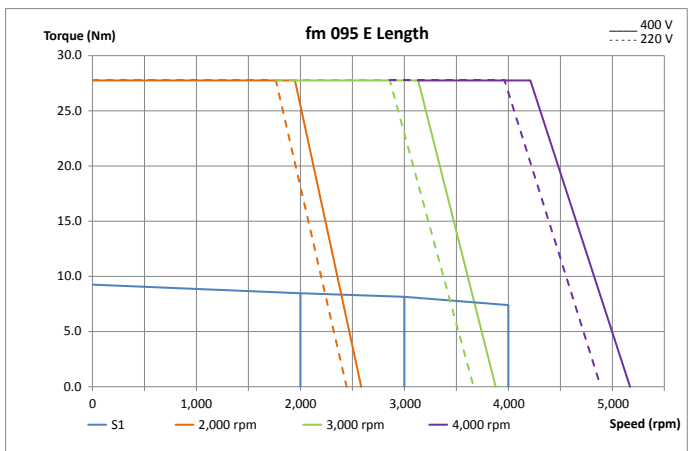
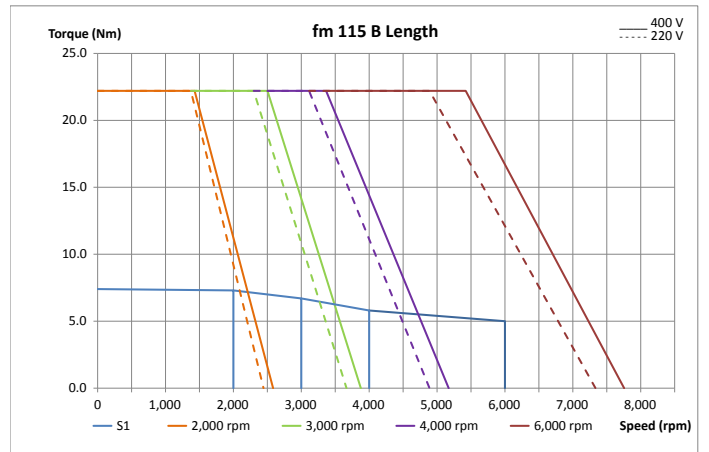
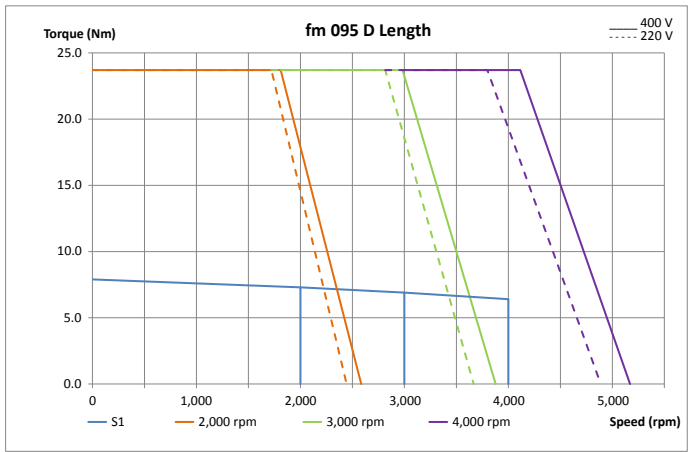
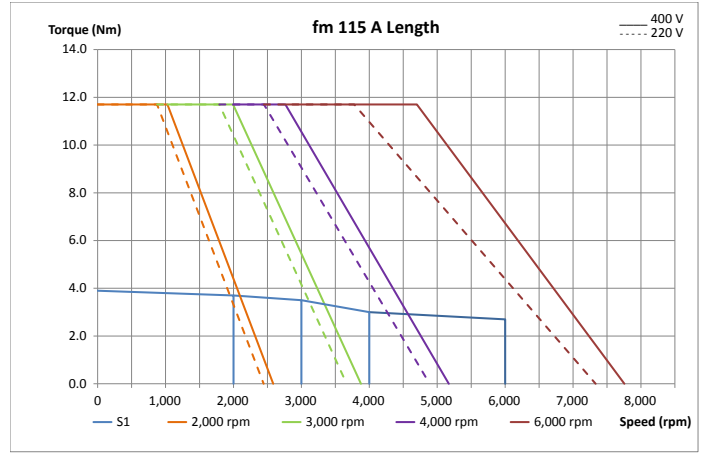
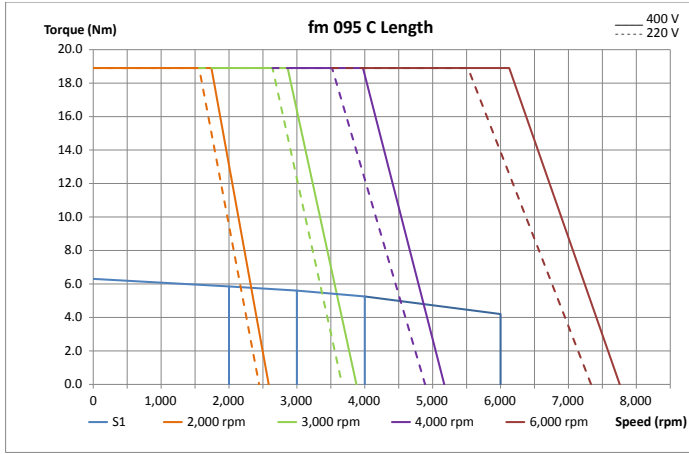

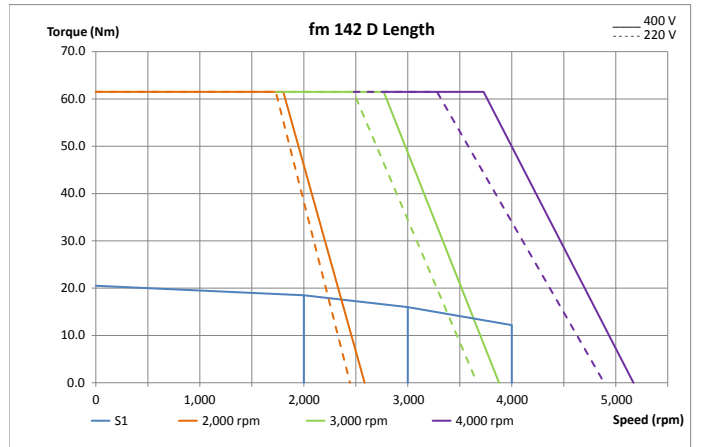
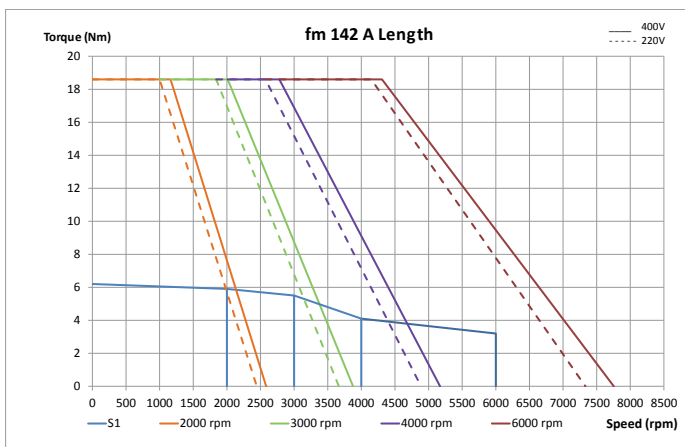
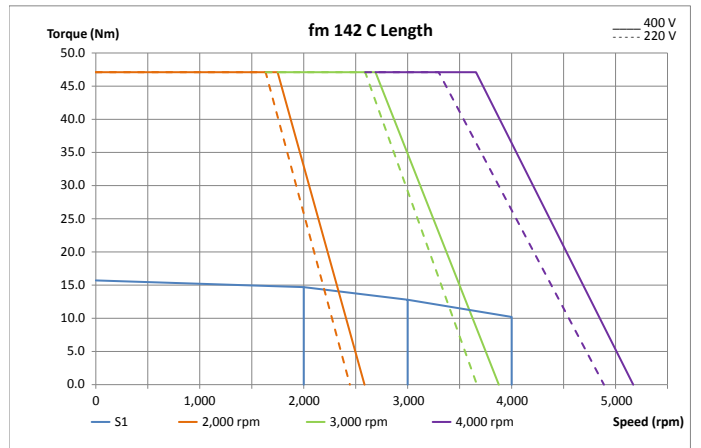
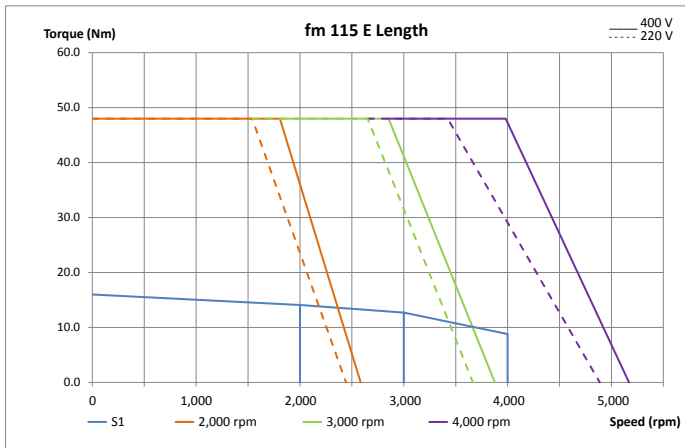
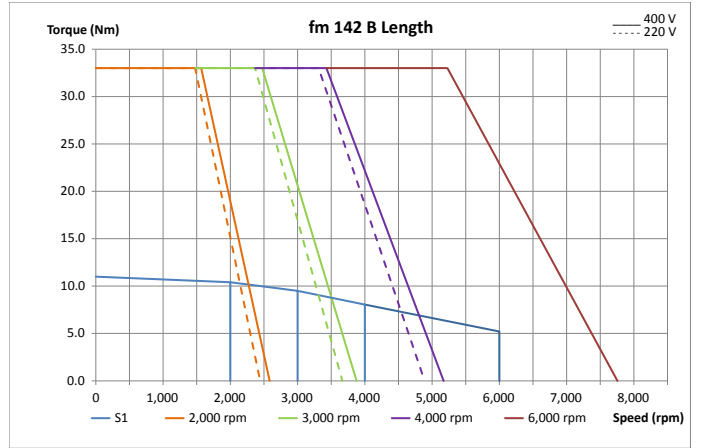
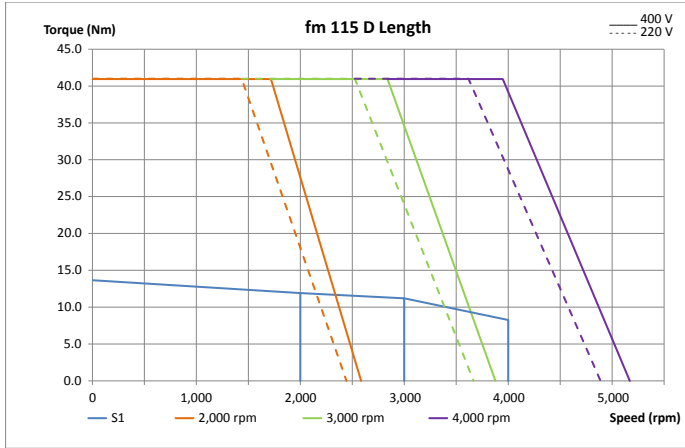

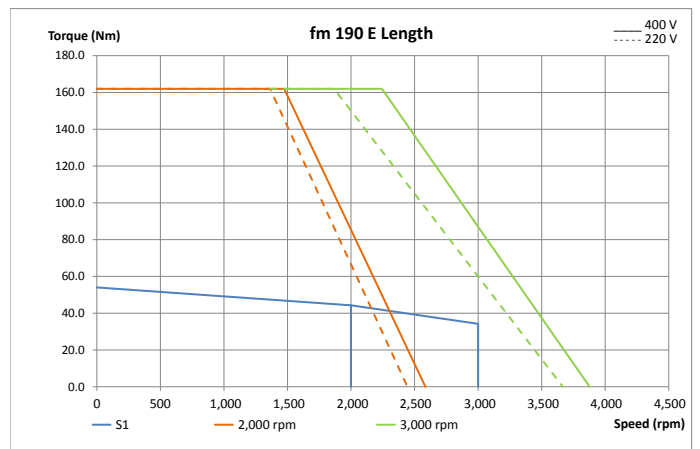
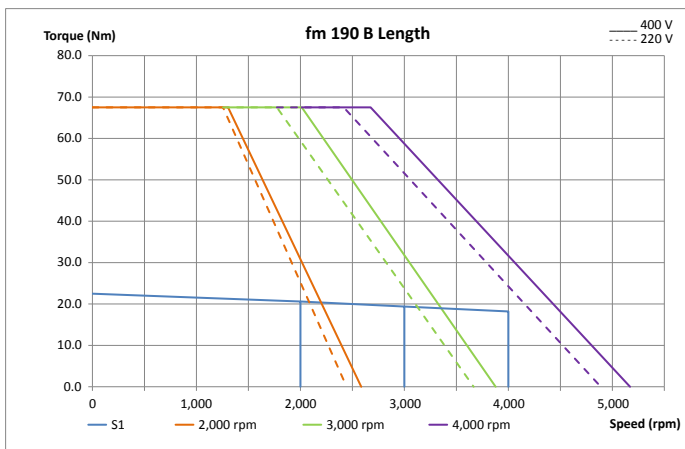
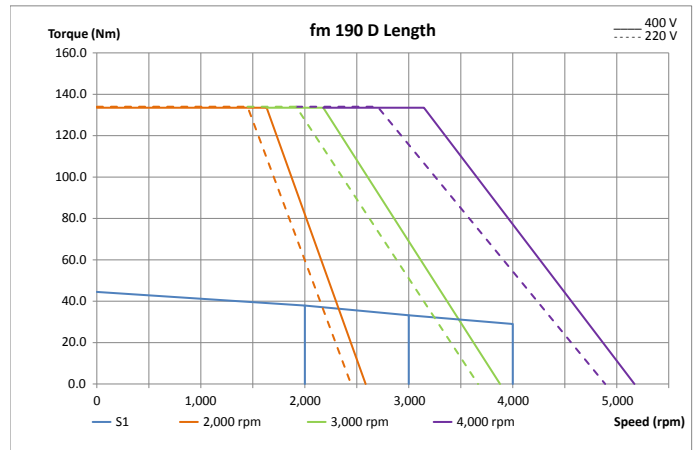
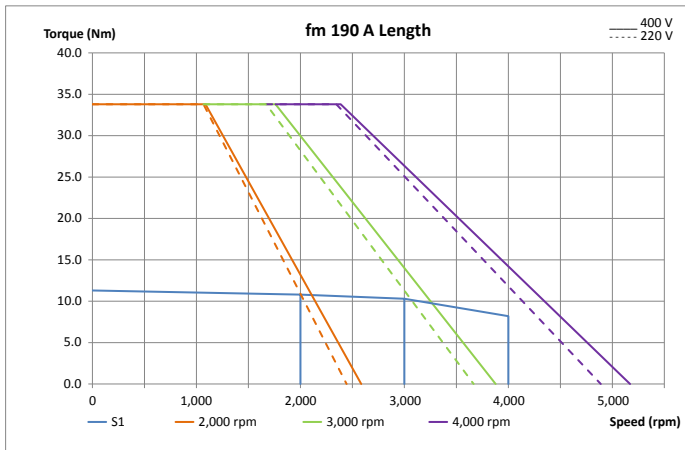
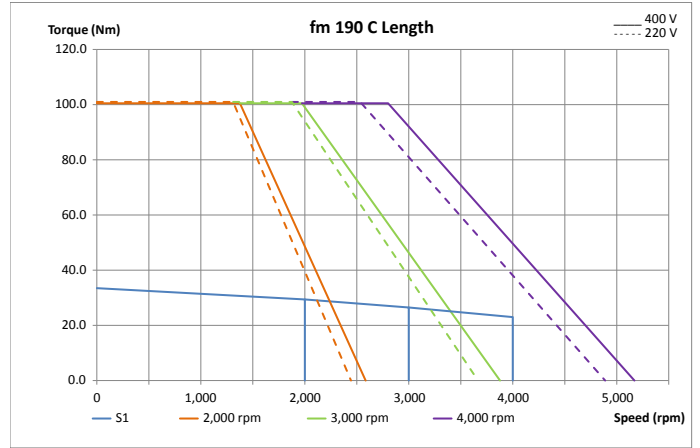
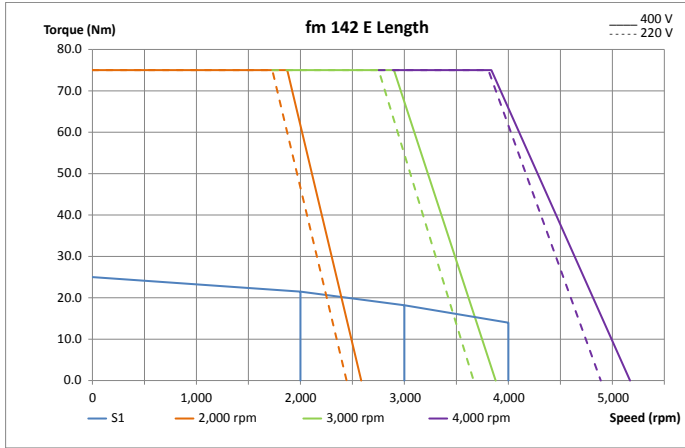

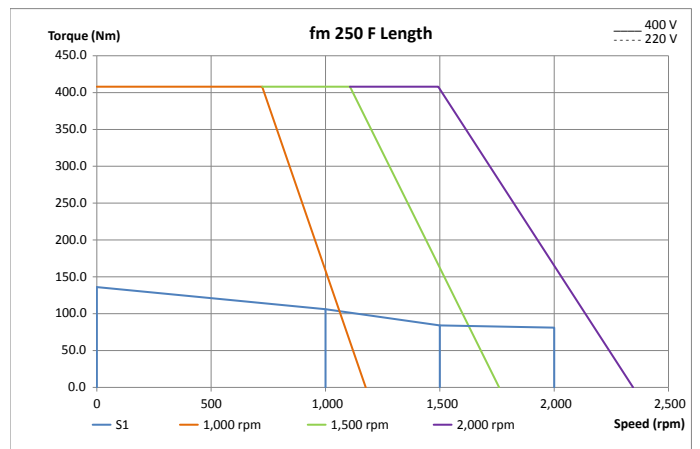
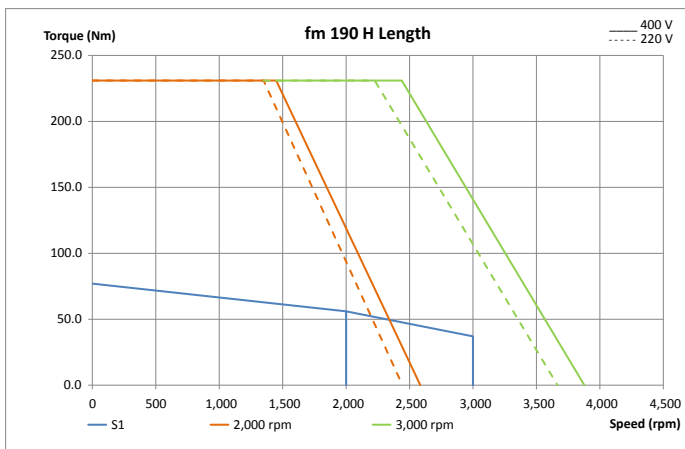
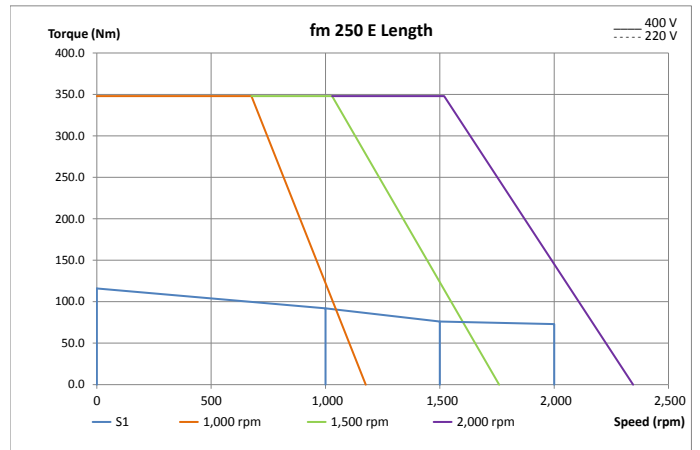
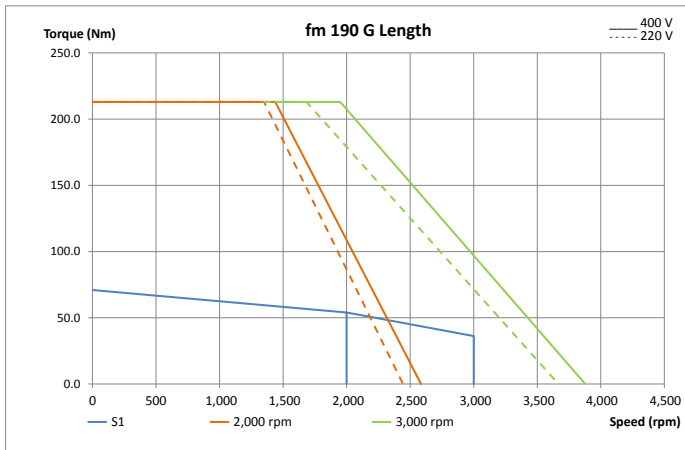
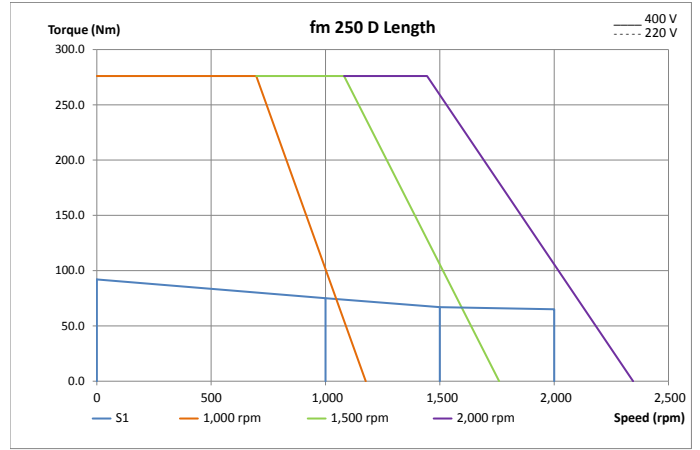
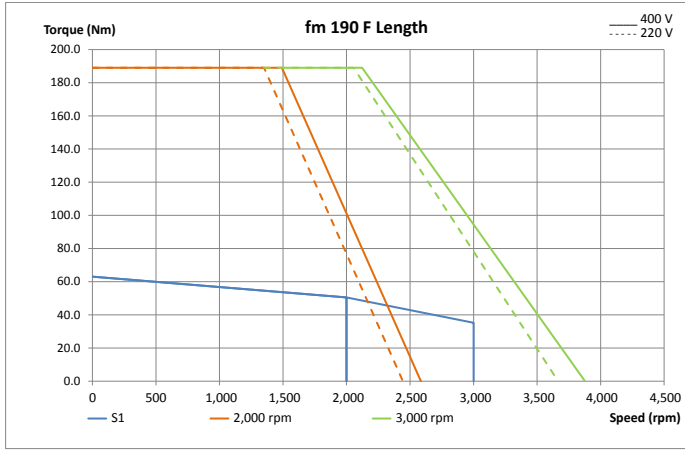

4.2 Unimotor hd

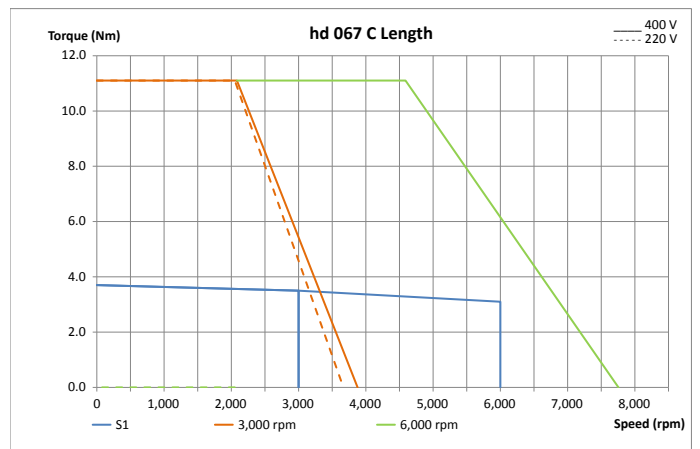
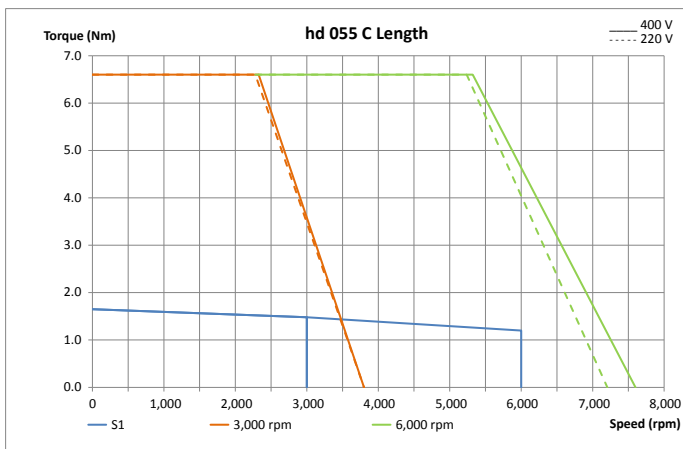
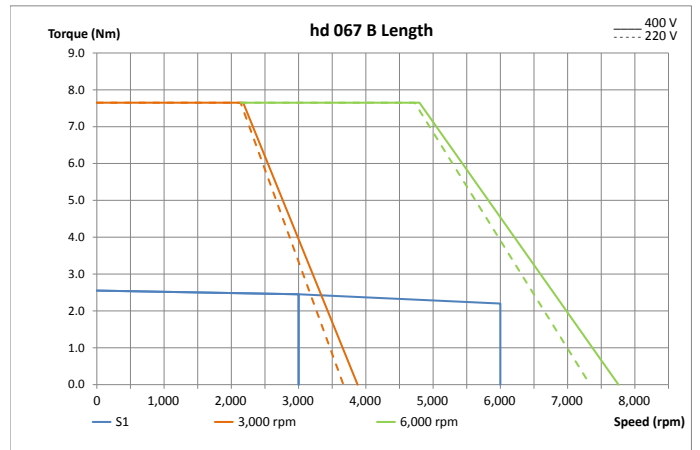
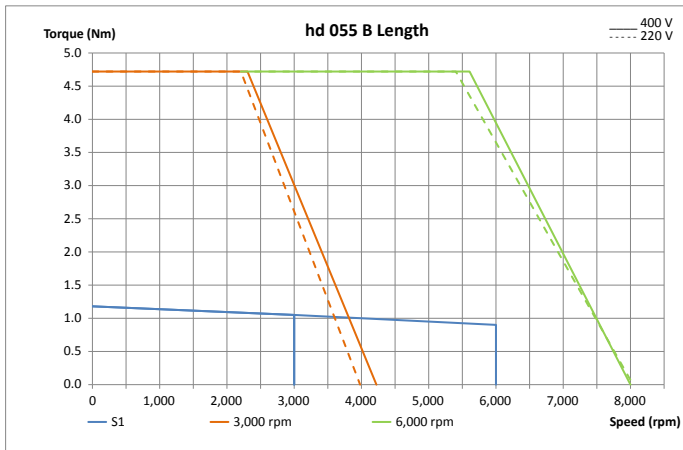
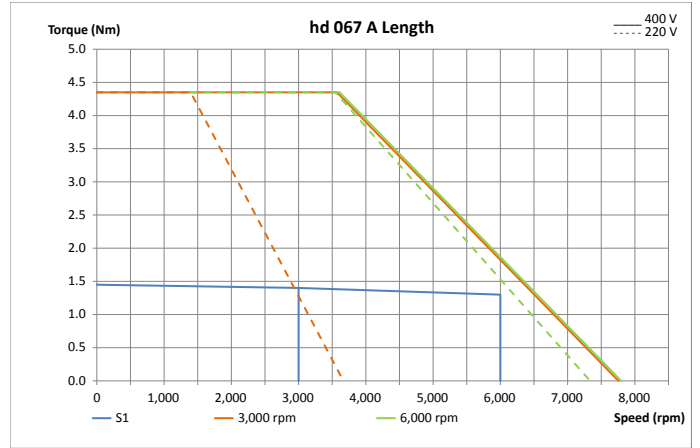
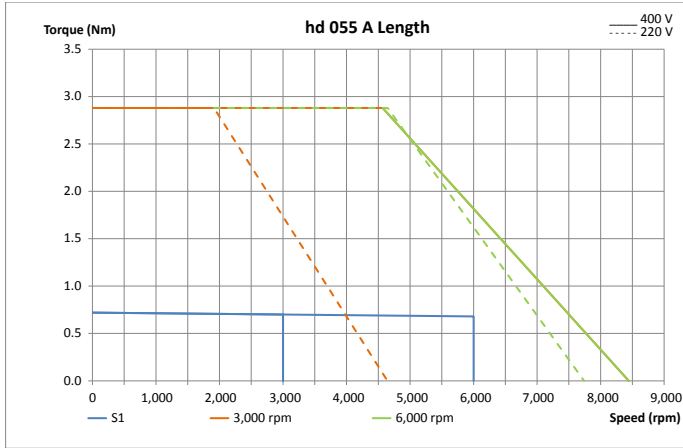

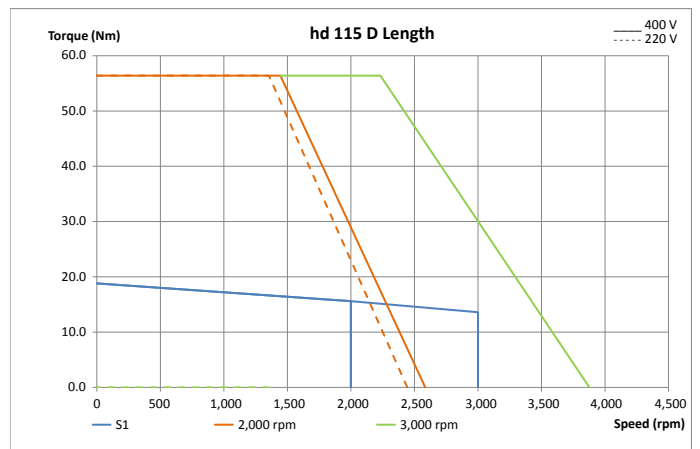
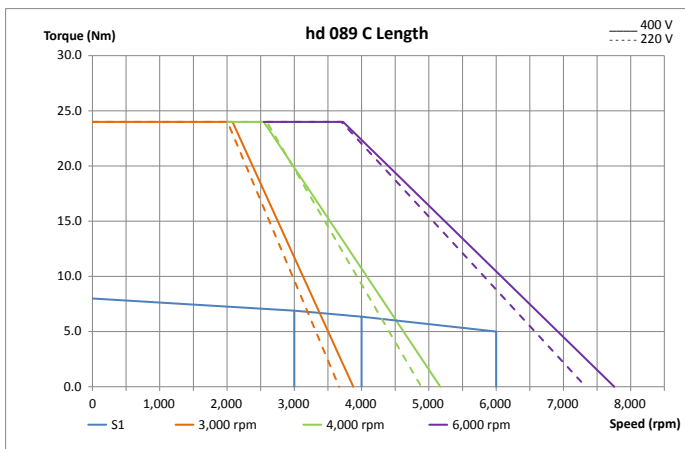
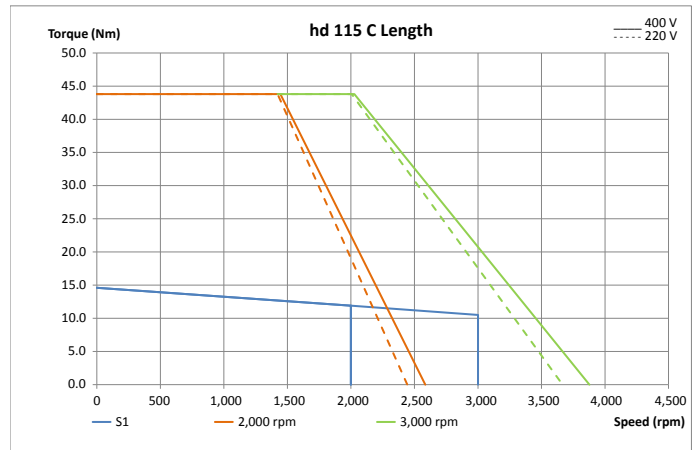
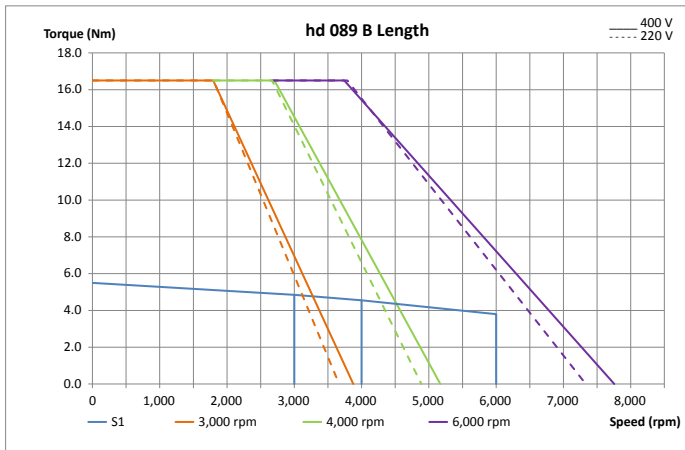
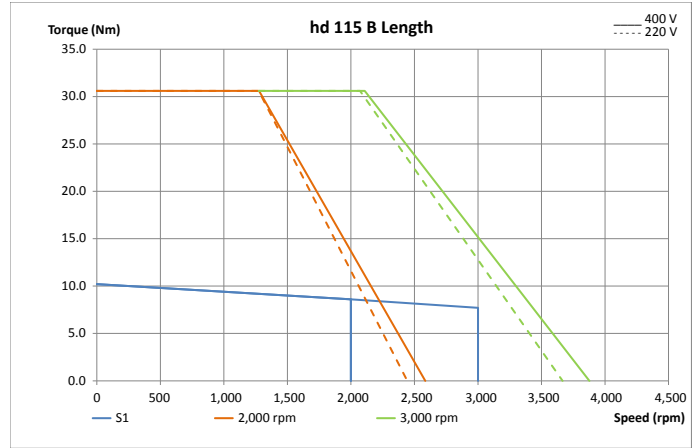
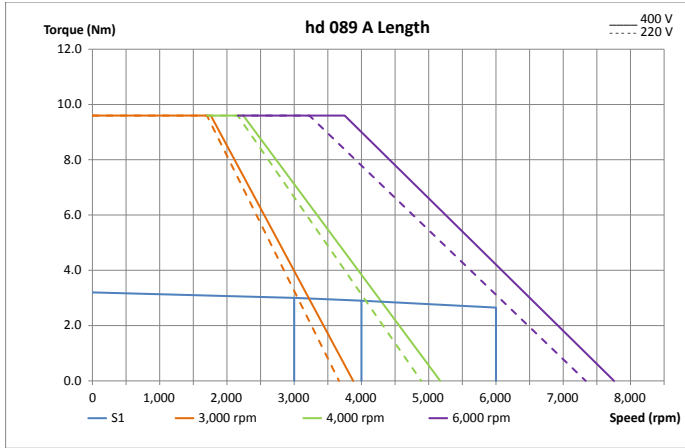

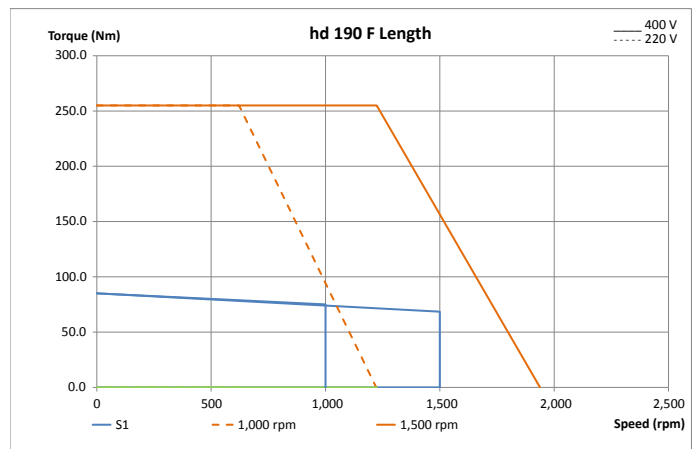
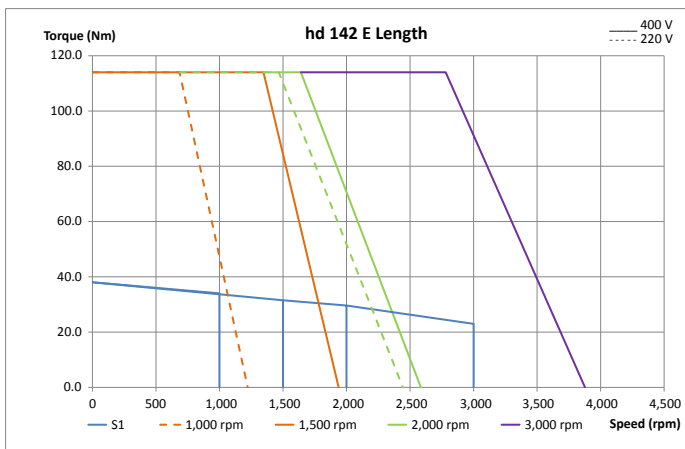
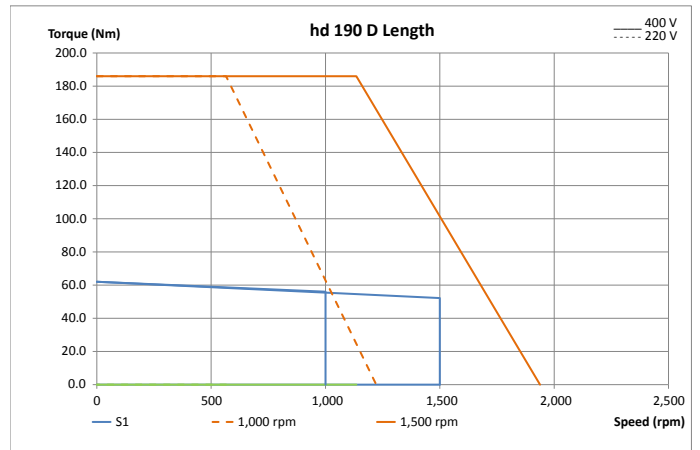
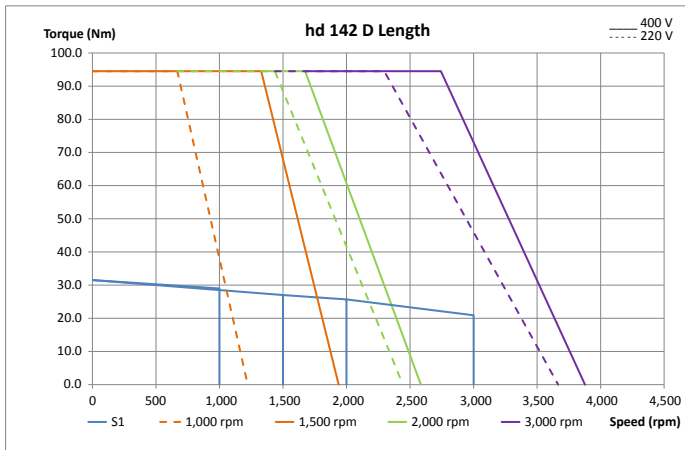
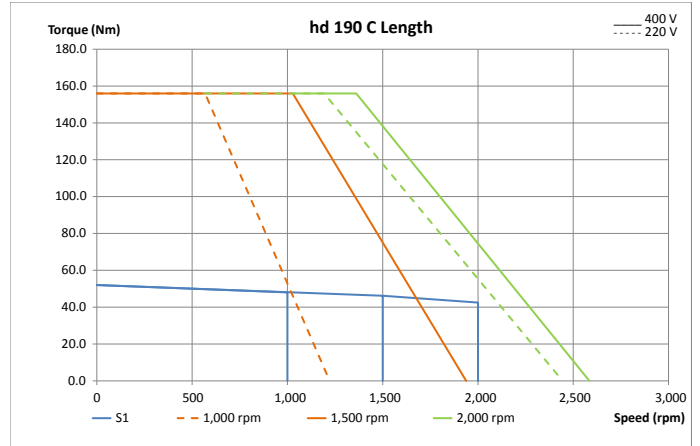
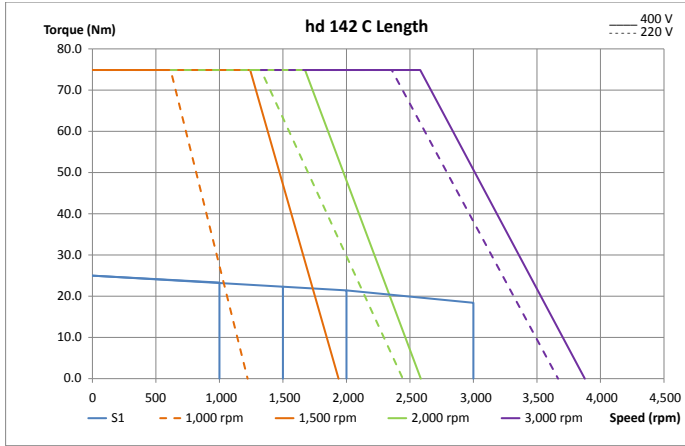



Case Study 2 - Servo drives increase throughput of shrink wrapping machines

MIMI is one of Italy's leading manufacturers of shrink-wrapping machines.

The Challenge

When MIMI was developing its new MITO shrink-wrapping machine, the company turned to Control Techniques and Leroy-Somer to provide a servo solution. The MITO machine is designed for wrapping different configurations and pack sizes of bottles, cartons, cans and tubs, and its key selling point is its flexibility. MITO needed a drive that could be quickly and easily set up for different bundles and pack sizes, with different configurations and even different products.

The Solution

MIMI chose Digitax ST for its MITO machines. The drives were incorporated into three critical areas of the machines – speed of throughput, the cutting of the wrapping film and control of the wrapping action. Each Digitax ST is equipped with an SM-Applications module that provides onboard PLC functionality. Control Techniques' expert automation engineers worked closely with MIMI to help develop MITO and to ensure that the chosen automation solution met their needs.

The Benefits

- Increased machine throughput
- Onboard PLC functionality
- Easy reconfiguring of motors

5 Unidrive M700 and Digitax ST servo drives for continuous and pulse duty applications

5.1 Unidrive M700 – continuous duty

0.7 Nm – 136 Nm (408 Nm peak)

Unidrive M700 is an AC and servo drive optimized for continuous duty. Unidrive M700 offers class leading servo and induction motor performance with onboard real-time Ethernet. The drive provides high performance motor control to satisfy the requirements of machine builders and high performance industrial applications.

5.1.1 Benefits

Maximize throughput with superior motor control

- High bandwidth motor control algorithm for closed-loop induction, permanent magnet and servo motors - 3,000 Hz current loop bandwidth and 250 Hz speed loop bandwidth
- Flexible speed and position feedback interface supports a wide range of feedback technologies from robust resolvers to high resolution encoders
 - Up to three encoder channels simultaneously e.g. 1 feedback encoder, 1 reference encoder and 1 simulated output
 - Quadrature, SinCos (including absolute), SSI, EnDat (up to 4 Mb with EnDat 2.2 and 100 m of cable as line compensation is supported) and resolvers
 - Simulated encoder output can provide position reference for CAMs, digital lock and electronic gearbox applications

Optimize system performance with onboard Advanced Motion Controller

- M700 incorporates an Advanced Motion Controller capable of controlling 1.5 axis. The motion functions are carried out 'on the drive' so that system performance is maximized.

Design flexible centralized and decentralized control systems

- Onboard PLC for logic programs
- MCI modules can be added to execute larger programs for advanced system control capability
- Machine Control Studio is an industry standard IEC61131-3 programming environment for efficient system design and configuration
- Integrated dual port Ethernet switch provides simple connectivity using standard connections
- Onboard real-time Ethernet (IEEE 1588 V2) uses RTMoE (Real Time Motion over Ethernet) to provide fast communication and accurate axis synchronization
- Three System Integration ports are available to fit additional fieldbus, position feedback and I/O options

Flexible machine design with options modules

Unidrive M700 can be tailored for a wide variety of demanding servo and induction applications. The drive has three option slots for System Integration modules, giving maximum flexibility

- Machine control: MCI200, MCI210, SI-Applications Plus
- Communications: SI-Ethernet, SI-PROFINET RT, SI-EtherCAT, SI-CANopen, SI-PROFIBUS, SI-DeviceNet
- Safety: SI-Safety
- Additional I/O: SI-I/O
- Feedback: SI-Encoder, SI-Universal Encoder
- 15 way D-type converter
- Single ended encoder interface (15 V or 24 V)

Conform to safety standards, maximize uptime and reduce costs by integrating directly with safety systems

- M700 has an integrated STO input and can accommodate an SI-Safety module for safe motion functions

Auxiliary power system flexibility

- Unidrive M can run with a wider operating DC voltage input, from 24 V up to maximum rated Volts providing optimum choice of auxiliary power supply for back-up purposes

5.1.2 Unidrive M700 variants: M701 and M702

Unidrive M701

Unidrive M701 has 2 x RS485 ports onboard instead of Ethernet. Parameter sets can be ported to Unidrive M using a smartcard or Unidrive M connect. Unidrive M701 is a direct upgrade for Unidrive SP users.

Unidrive M702 – Enhanced Safety

Unidrive M702 has an additional STO input for applications that require onboard Ethernet and dual STO to comply with SIL 3 PLe.



5.2 Servo drives: Digitax ST – pulse duty

From 0.72 Nm to 18.8 Nm (56.4 Nm Peak)

Digitax ST is a dedicated servo drive optimized for pulse duty. The drive is designed to help meet the demands of modern manufacturers for smaller, more flexible and higher performing machinery.

5.2.1 Benefits

Maximize throughput with superior motor control

- High bandwidth motor control algorithm for servo motors
- Optimum performance for high-dynamic applications with 300 % overload
- Supports a wide range of feedback technologies from robust resolvers to high resolution encoders
 - Up to two encoder channels simultaneously e.g. 1 feedback encoder and 1 simulated output
 - Quadrature, SinCos, SSI, EnDat, Hiperface
 - Robust resolvers (SM resolver module required)
 - Simulated encoder output can provide position reference for CAMs, digital

Reduce cabinet size with compact drive design

- Digitax ST is compact and can be flush mounted which at high current ratings can save up to 50 % of cabinet space compared to competitor products
- Onboard features such as Safe Torque Off reduce the need for external components

Flexible machine design with option modules

Digitax drives can be tailored for a variety of applications. Two option slots allow increasing capabilities.

- Communication options: to support Ethernet or popular fieldbuses such as Ethernet/IP, PROFIBUS-DP and CANopen
- Feedback options: to support resolvers, or to increase the number of encoder inputs/outputs
- Input and output options: for additional on-board digital, analog or high-speed I/O
- Application modules: second processor for specific applications such as register control (see page 11 for a full list of available option modules)

Reduced development time

- Three motion programming options:
 - CTSoft index motion
 - SyPTPro
 - PowerTools Pro
- Fieldbus option modules are independently certified for conformity with open standards
- 2D and 3D CAD files to make it easier and quicker to design the drive into your machine

Quicker installation

- The top or bottom of the drive can be located onto a DIN rail
- Features grounding brackets and cable management support for easy mounting
- Pluggable control terminals enable looms to be easily prepared

Reduced commissioning time

- Digitax ST can be quickly configured using the removable keypad, Smartcard or supplied commissioning software
- Autotune gets the best performance by measuring machine dynamics and automatically optimizing control loop gains
- CTScope – a realtime software oscilloscope – is supplied for tuning and monitoring
- Motor data can be retrieved automatically from the electronic nameplate on the digital encoder

Auxiliary power system flexibility

- Digitax ST can run with a wider operating DC voltage input, from 48 V up to maximum rated Volts providing optimum choice of auxiliary power supply for back-up purposes

5.2.2 Digitax ST is available in five variants:

- EtherCAT - Built in EtherCAT connectivity
- Plus - With on board APC motion controller
- EZ Motion - Easy-to-use motion programming
- Indexer - Point-to-point positioning functionality
- Base - Digital or analog control



5.3 Drive and motor combinations

055 hd

Drive part number				DST1201 1Ph	DST1201 3Ph	DST1202 1Ph	DST1202 3Ph	DST1203 1Ph	DST1203 3Ph	DST1204 1Ph	DST1401 3Ph	DST1402 3Ph	M700-03200050A	M700-03200066A	M700-03200080A	M700-03400025A	M700-03400031A	M700-03400045A	
Drive switching frequency				12						8		12							
Rated drive current				1.1	1.7	2.4	3.8	2.9	5.4	4.7	1.5	2.7	5.0	6.6	8.0	2.5	3.1	4.5	
Drive output maximal current				2.2	5.1	4.8	11.4	5.8	16.2	9.4	4.5	8.1	10.0	13.2	16.0	5.0	6.2	9.0	
Rated motor speed	Motor stall torque	Motor type	Combined drive and motor performance																
3000	0.7	055 ED A 30	Mo	0.7	0.7	0.7							0.7						
			Mn	0.7	0.7	0.7							0.7						
			Mmax	1.6	2.9	2.9							2.9						
		055 UD A 30	Mo								0.7						0.7		
			Mn								0.7						0.7		
			Mmax								2.9						2.9		
	1.2	055 ED B 30	Mo		1.2	1.2	1.2	1.2						1.2					
			Mn		1.1	1.1	1.1	1.1						1.1					
			Mmax		4.4	4.2	4.7	4.7						4.7					
		055 UD B 30	Mo									1.1					1.2		
			Mn									1.0					1.1		
			Mmax									4.7					4.7		
1.7	055 ED C 30	Mo			1.7	1.7	1.7		1.7				1.7						
		Mn			1.5	1.5	1.5	1.5					1.5						
		Mmax			4.4	6.6	5.3	6.6					6.6						
	055 UD C 30	Mo									1.6					1.7			
		Mn									1.4					1.5			
		Mmax									6.6					6.6			
6000	0.7	055 ED A 60	Mo		0.7	0.7	0.7	0.7		0.7			0.7						
			Mn		0.7	0.7	0.7	0.7		0.7			0.7						
			Mmax		2.3	2.1	2.9	2.6	2.9					2.9					
		055 UD A 60	Mo									0.7					0.7		
			Mn									0.7					0.7		
			Mmax									2.9					2.9		
	1.2	055 ED B 60	Mo				1.2	1.2		1.2			1.2	1.2					
			Mn				0.9	0.9		0.9			0.9	0.9					
			Mmax				4.7	2.5	4.0				4.3	4.7					
		055 UD B 60	Mo									1.2	1.2				1.2	1.2	
			Mn									0.9	0.9				0.9	0.9	
			Mmax									3.6	4.7				4.0	4.7	
1.7	055 ED C 60	Mo				1.7		1.7	1.7			1.7	1.7	1.7					
		Mn				1.2		1.2	1.2			1.2	1.2	1.2					
		Mmax				5.5		6.6	4.5			4.8	6.3	6.6					
	055 UD C 60	Mo										1.7				1.7	1.7	1.7	
		Mn										1.2				1.2	1.2	1.2	
		Mmax										6.6				4.2	5.2	6.6	

Key

Mo = stall torque (Nm)

Mn = rated torque

Mmax = maximum torque



Case Study 3 - Unidrive M brings throughput and efficiency improvements to fastening presses

Penn Engineering, a global leader in fastening solutions, is using Unidrive M in servo-driven presses to insert fasteners primarily for the European and North American markets.

The Challenge

Penn needed to change its existing systems from air over oil to electric. This would result in a number of positive benefits, including the elimination of oil leak issues which were crucial in specific markets. The new system would also need to deliver greater flexibility, increased cycle rates and RoHS compliance.

The solution

Working with Control Techniques, a highly customized system was commissioned utilizing Unidrive M700 and M701 drives which control one linear device. The motors enable and disable on the fly to hand off from one motor to the other, with seamless motion, to control the same linear device.

The Benefits

- Increased efficiency and throughput
- RoHS compliance
- Significant cost savings



067 hd

Drive part number				DST1 201 3Ph	DST1 202 1Ph	DST1 202 3Ph	DST1 203 1Ph	DST1 203 3Ph	DST1 204 1Ph	DST1 204 3Ph	DST1 402 3Ph	DST1 403 3Ph	DST1 404 3Ph	M700-03200050 A	M700-03200066 A	M700-03200080 A							
Drive switching frequency				12		6		12		6		8		6		12 3							
Rated drive current				1.7	2.4	3.8		2.9	5.4	4.7	7.6	2.7	4.0	5.9	5.0		6.6	8.0					
Drive output maximal current				5.1	4.8	11.4	11.4	5.8	16.2	9.4	9.4	22.8	8.1	8.1	12.0	17.7	10.0	10.0	13.2	13.2	16.0		
Rated motor speed	Motor stall torque	Motor type	Combined drive and motor performance																				
3000	1.5	067 ED A 30	Mo	1.5	1.5										1.5								
			Mn	1.4	1.4										1.4								
			Mmax	4.4	4.4											4.4							
		067 UD A 30	Mo									1.4											
			Mn									1.4											
			Mmax									4.4											
	2.6	067 ED B 30	Mo			2.6	2.6	2.6								2.6							
			Mn			2.5	2.5	2.5								2.5							
			Mmax			7.7	5.4	7.7								7.7							
		067 UD B 30	Mo									2.5											
			Mn									2.4											
			Mmax									7.7											
3.7	067 ED C 30	Mo			3.5	3.7	3.7								3.7	3.7							
		Mn			3.3	3.5	3.5								3.5	3.5							
		Mmax			10.6	11.1	8.7								9.3	11.1							
	067 UD C 30	Mo									3.6												
		Mn									3.4												
		Mmax									11.1												
6000	1.5	067 ED A 60	Mo			1.5			1.5						1.5								
			Mn			1.3			1.3							1.3							
			Mmax			4.4			4.4							4.4							
		067 UD A 60	Mo									1.5											
			Mn									1.3											
			Mmax									4.4											
	2.6	067 ED B 60	Mo								2.6									2.6	2.6		
			Mn									2.2									2.2	2.2	
			Mmax									7.7									6.2	7.5	
		067 UD B 60	Mo										2.6										
			Mn										2.2										
			Mmax										7.7										
3.7	067 UD C 60	Mo											3.7										
		Mn											3.1										
		Mmax											11.1										

Key

Mo = stall torque

Mn = rated torque

Mmax = maximum torque

	M700-03200106A	M700-03400025A	M700-03400031A	M700-03400045A	M700-03400062A	M700-03400078A	Drive part number								
	3	12	3	12	3	12		3		Drive switching frequency					
	10.6	2.5	2.5	3.1	3.1	4.5	4.5	6.2	7.8	Rated drive current					
	21.2	5.0	5.0	6.2	6.2	9.0	9.0	12.4	15.6	Drive output maximal current					
										Combined drive and motor performance	Motor type	Motor stall torque	Rated motor speed		
										Mo	067 ED A 30	1.5	3000		
										Mn					
										Mmax					
		1.5		1.5						Mo	067 UD A 30	1.5		3000	
		1.4		1.4						Mn					
		4.0		4.4						Mmax					
										Mo	067 ED B 30	2.6			3000
										Mn					
										Mmax					
		2.6								Mo	067 UD B 30	2.6	3000		
		2.5								Mn					
		7.7								Mmax					
										Mo	067 ED C 30	3.7		3000	
										Mn					
										Mmax					
		3.7		3.7		3.7				Mo	067 UD C 30	3.7			3000
		3.5		3.5		3.5				Mn					
		8.0		9.9		11.1				Mmax					
										Mo	067 ED A 60	1.5	6000		
										Mn					
										Mmax					
			1.5		1.5					Mo	067 UD A 60	1.5		6000	
			1.3		1.3					Mn					
			4.0		4.4					Mmax					
	2.6									Mo	067 ED B 60	2.6			6000
	2.2									Mn					
	7.7									Mmax					
						2.6	2.6			Mo	067 UD B 60	2.6	6000		
						2.2	2.2			Mn					
						7.2	7.7			Mmax					
								3.7	3.7	Mo	067 UD C 60	3.7		6000	
								3.1	3.1	Mn					
								9.9	11.1	Mmax					

089 hd

Drive part number				DST1202 3Ph	DST1203 3Ph	DST1204 1Ph	DST1204 3Ph	DST1402 3Ph	DST1403 3Ph	DST1404 3Ph	DST1405 3Ph	M700-03200050 A	M700-03200066A	M700-03200080 A	M700-03200106A	M700-03400025A	
Drive switching frequency				12			8			12		4		12			
Rated drive current				5.4		4.7		7.6		2.7		4.0		5.9		8.0	
Drive output maximal current				16.2		9.4		22.8		8.1		12.0		17.7		24.0	
Rated motor speed	Motor stall torque	Motor type	Combined drive and motor performance														
3000	3.2	089 ED A 30	Mo	3.2		3.2						3.2	3.2				
			Mn	3.0		3.0						3.0	3.0				
			Mmax	9.6		8.7						9.3	9.6				
		089 UD A 30	Mo					3.1									3.2
			Mn					2.9									3.0
			Mmax					9.6									8.0
	5.5	089 ED B 30	Mo			5.5							5.5	5.5		5.5	
			Mn			4.9						4.9	4.9		4.9		
			Mmax			16.5						12.3	14.9		16.5		
		089 UD B 30	Mo					5.3									
			Mn					4.7									
			Mmax					16.5									
8.0	089 ED C 30	Mo												7.3	8.0		
		Mn											6.3	6.9			
		Mmax											14.9	19.7			
	089 UD C 30	Mo							7.8								
		Mn							6.7								
		Mmax							24.0								
4000	3.2	089 ED A 40	Mo		3.2	3.2						3.2	3.2	3.2			
			Mn		2.9	2.9					2.9	2.9	2.9				
			Mmax		9.6	6.6					7.0	9.2	9.6				
		089 UD A 40	Mo					3.2									
			Mn					2.9									
			Mmax					9.6									
	5.5	089 ED B 40	Mo											5.5		5.5	
			Mn											4.6		4.6	
			Mmax											11.2		14.8	
		089 UD B 40	Mo							5.5							
			Mn							4.6							
			Mmax							16.5							
8.0	089 ED C 40	Mo															
		Mn															
		Mmax															
	089 UD C 40	Mo								8.0							
		Mn								6.4							
		Mmax								24.0							
6000	3.2	089 ED A 60	Mo			3.2							3.2		3.2		
			Mn			2.7						2.7		2.7			
			Mmax			9.6						7.5		9.6			
		089 UD A 60	Mo					3.2									
			Mn					2.7									
			Mmax					9.6									
	5.5	089 ED B 60	Mo														
			Mn														
			Mmax														
		089 UD B 60	Mo								5.5						
			Mn								3.8						
			Mmax								16.5						
8.0	089 ED C 60	Mo															
		Mn															
		Mmax															
	089 UD C 60	Mo															
		Mn															
		Mmax															

Key Mo = stall torque Mn = rated torque Mmax = maximum torque

M700-03400031A		M700-03400045A		M700-03400062A		M700-03400078A		M700-03400100A		M700-04200137A	M700-04200185A	M700-04400150A	M700-05200250A	M700-06200330A	Drive part number			
12	3	12	3	12	8	12	8	4	12						Drive switching frequency			
3.1		4.5		5.8		5.7	7.6	7.7	10.0	13.7	17.6	11.5	21.5	32.0	Rated drive current			
6.2	6.2	9.0	9.0	12.4	12.4	15.6	15.6	20.0	20.0	27.4	37.0	30.0	50.0	66.0	Drive output maximal current			
															Combined drive and motor performance	Motor type	Motor stall torque	Rated motor speed
															Mo	089 ED A 30	3.2	3000
															Mn			
															Mmax			
															Mo	089 UD A 30	3.2	
															Mn			
															Mmax			
															Mo	089 ED B 30	5.5	
															Mn			
															Mmax			
															Mo	089 UD B 30	5.5	
															Mn			
															Mmax			
															Mo	089 ED C 30	8.0	
															Mn			
															Mmax			
															Mo	089 UD C 30	8.0	
															Mn			
															Mmax			
															Mo	089 ED A 40	3.2	
															Mn			
															Mmax			
															Mo	089 UD A 40	3.2	
															Mn			
															Mmax			
															Mo	089 ED B 40	5.5	
															Mn			
															Mmax			
															Mo	089 UD B 40	5.5	
															Mn			
															Mmax			
															Mo	089 ED C 40	8.0	
															Mn			
															Mmax			
															Mo	089 UD C 40	8.0	
															Mn			
															Mmax			
															Mo	089 ED A 60	3.2	
															Mn			
															Mmax			
															Mo	089 UD A 60	3.2	
															Mn			
															Mmax			
															Mo	089 ED B 60	5.5	
															Mn			
															Mmax			
															Mo	089 UD B 60	5.5	
															Mn			
															Mmax			
															Mo	089 ED C 60	8.0	
															Mn			
															Mmax			
															Mo	089 UD C 60	8.0	
															Mn			
															Mmax			

115 hd

Drive part number				DST1204 3Ph	DST1404 3Ph		DST1405 3Ph	M700-03200066A	M700-03200080A	M700-03200106A		M700-03400045A	M700-03400062A	M700-03400078A					
Drive switching frequency				12	8	6	8	3	12	8	6	12	6	12	8	6			
Rated drive current				7.6	5.9		8.0	6.6	8.0	8.8	10.6		4.5	6.2	5.7	7.6	7.8		
Drive output maximal current				22.8	17.7	17.7	24.0	13.2	16.0	21.2	21.2	21.2	9.0	12.4	12.4	15.6	15.6	15.6	
Rated motor speed	Motor stall torque	Motor type	Combined drive and motor performance																
2000	10.2	115 ED B 20	Mo	10.2				9.1	10.2	10.2									
			Mn	8.6				7.7	8.6	8.6									
			Mmax	30.6				18.5	22.4	29.7									
		115 UD B 20	Mo		10.0								10.2	10.2		10.2			
			Mn		8.4								8.6	8.6		8.6			
			Mmax		30.6								21.6	29.8		30.6			
	14.6	115 ED C 20	Mo								14.3								
			Mn								11.7								
			Mmax								29.7								
		115 UD C 20	Mo		14.0	14.3									14.0		14.3		
			Mn		11.4	11.7									11.4		11.7		
			Mmax		42.5	43.8									29.8		37.4		
18.8	115 ED D 20	Mo																	
		Mn																	
		Mmax																	
	115 UD D 20	Mo			18.4												18.1		
		Mn			15.3												15.0		
		Mmax			56.4												37.4		
3000	10.2	115 ED B 30	Mo								9.8								
			Mn								7.4								
			Mmax									19.7							
		115 UD B 30	Mo			10.0									9.8		10.0		
			Mn			7.6									7.4		7.6		
			Mmax			30.6									19.8		25.0		
	14.6	115 ED C 30	Mo																
			Mn																
			Mmax																
		115 UD C 30	Mo																
			Mn																
			Mmax																
18.8	115 UD D 30	Mo																	
		Mn																	
		Mmax																	

Key

Mo = stall torque

Mn = rated torque

Mmax = maximum torque

M700-03400100 A		M700-04200137 A		M700-04200185 A		M700-04400150 A		M700-04400172 A		M700-05200250 A		M700-05400270 A		Drive part number										
8		6		12				8		12				Drive switching frequency										
7.7		9.2		13.7		17.6		11.5		14.4		21.5		13.8		Rated drive current								
20.0		20.0		27.4		37.0		30.0		30.0		34.4		50.0		54.0		Drive output maximal current						
																		Combined drive and motor performance						
																		Motor type						
																		Motor stall torque						
																		Rated motor speed						
				10.2														Mo	115 ED B 20	10.2	2000			
				8.6														Mn						
				30.6														Mmax						
																		Mo	115 UD B 20					
																		Mn						
																		Mmax						
				14.6	14.6													Mo	115 ED C 20	14.6				
				11.9	11.9													Mn						
				38.4	43.8													Mmax						
14.3							14.6											Mo	115 UD C 20					
11.7							11.9											Mn						
43.8							43.8											Mmax						
				18.8	18.8					18.8								Mo	115 ED D 20					
				15.6	15.6					15.6								Mn						
				38.4	51.8					56.4								Mmax						
18.4							18.8											Mo	115 UD D 20	18.8				
15.3							15.6											Mn						
48.0							56.4											Mmax						
				10.2	10.2													Mo	115 ED B 30	10.2			3000	
				7.7	7.7													Mn						
				25.5	30.6													Mmax						
10.0							10.2											Mo	115 UD B 30					
7.6							7.7											Mn						
30.6							30.6											Mmax						
							14.6				14.6							Mo	115 ED C 30	14.6				
							10.5				10.5							Mn						
							34.4				43.8							Mmax						
				14.0			14.6											Mo	115 UD C 30					
				10.1			10.5											Mn						
				32.0			43.8											Mmax						
							18.4	18.4			18.8							Mo	115 UD D 30	18.8				
							13.3	13.3			13.6							Mn						
							48.0	55.0			56.4							Mmax						



142 hd

Drive part number				DSTI 405 3Ph	M700-03200080A	M700-03200106A	M700-03400078A	M700-03400100A			M700-04200137A		M700-04200185A		M700-04400150A			M700-04400172A						
Drive switching frequency				8	6	8		6	3	12	8	12	8	6	12	8	6	4						
Rated drive current				8.0	8.0	10.6	7.6	7.7	9.2	10.0	13.7	17.6	18.5	11.5	14.4	15.0	11.5	14.4	16.1	17.2				
Drive output maximal current				24.0	16.0	21.2	15.6	20.0	20.0	20.0	27.4	37.0	37.0	30.0	30.0	30.0	34.4	34.4	34.4	34.4				
Rated motor speed	Motor stall torque	Motor type	Combined drive and motor performance																					
1000	25.0	142 ED C 10	Mo		22.0	22.8					25.0													
			Mn		20.5	21.2					23.3													
			Mmax		44.8	59.4					74.9													
	31.5	142 ED D 10	Mo			28.7					31.5	31.5												
			Mn			26.4					29.0	29.0												
			Mmax			59.4					76.7	94.5												
	38.0	142 ED E 10	Mo								38.0	38.0												
			Mn								34.5	34.5												
			Mmax								76.7	103.6												
1500	25.0	142 UD C 15	Mo	22.8			22.8	22.8						25.0										
			Mn	20.3			20.3	20.3							22.3									
			Mmax	74.9			49.9	64.0							74.9									
	31.5	142 UD D 15	Mo						27.7						31.5									
			Mn						23.8						27.0									
			Mmax						64.0						94.5									
	38.0	142 UD E 15	Mo							31.5					34.6					34.6				
			Mn								26.3				28.9					28.9				
			Mmax								64.0				96.0					110.1				
2000	25.0	142 ED C 20	Mo										22.8											
			Mn										19.5											
			Mmax										51.8											
	142 UD C 20	Mo							22.0					25.0					25.0					
		Mn							18.8					21.4					21.4					
		Mmax							48.0					72.0					74.9					
	31.5	142 ED D 20	Mo																					
			Mn																					
			Mmax																					
	142 UD D 20	Mo													28.7				28.7					
		Mn													23.4				23.4					
		Mmax													72.0				82.6					
	38.0	142 ED E 20	Mo																					
			Mn																					
			Mmax																					
142 UD E 20	Mo														33.4			33.4						
	Mn														26.1			26.1						
	Mmax														72.0			82.6						
3000	25.0	142 ED C 30	Mo																					
			Mn																					
			Mmax																					
	142 UD C 30	Mo												22.8					22.8					
		Mn												16.7					16.7					
		Mmax												48.0					55.0					
	31.5	142 ED D 30	Mo																					
			Mn																					
			Mmax																					
	142 UD D 30	Mo																				26.8		
		Mn																				17.8		
		Mmax																				55.0		
	38.0	142 UD E 30	Mo																					
			Mn																					
			Mmax																					

Key Mo = stall torque Mn = rated torque Mmax = maximum torque

M700-05200250 A		M700-05400270 A				M700-05400300 A		M700-06200330 A		M700-06200440 A		M700-06400350 A		M700-06400420 A	M700-07200610 A	M700-07400660 A	Drive part number			
12	8	12	8	6	4	8	6	12	8	12	8	12	8	12	8	12	Drive switching frequency			
21.5	24.8	13.8	17.6	20.3	23.7	21.0	24.0	32.0	33.0	33.0	40.0	23.0	30.0	30.0	61.0	41.0	Rated drive current			
50.0	50.0	54.0	54.0	54.0	54.0	66.0	66.0	66.0	66.0	88.0	88.0	70.0	70.0	84.0	122.0	132.0	Drive output maximal current			
																	Combined drive and motor performance	Motor type	Motor stall torque	Rated motor speed
																	Mo	142 ED C 10	25.0	1000
																Mn				
																Mmax				
																	Mo	142 ED D 10	31.5	
																Mn				
																Mmax				
38.0																	Mo	142 ED E 10	38.0	
34.5																Mn				
114.0																Mmax				
																	Mo	142 UD C 15	25.0	
																Mn				
																Mmax				
																	Mo	142 UD D 15	31.5	
																Mn				
																Mmax				
			38.0														Mo	142 UD E 15	38.0	
			31.7													Mn				
			114.0													Mmax				
25.0								25.0									Mo	142 ED C 20	25.0	
21.4								21.4								Mn				
70.0								74.9								Mmax				
																	Mo	142 UD C 20		25.0
																Mn				
																Mmax				
	28.7							31.5		31.5							Mo	142 ED D 20		31.5
	23.4							25.7		25.7							Mn			
	70.0							92.4		94.5							Mmax			
																	Mo	142 UD D 20	31.5	
																	Mn			
																	Mmax			
																	Mo	142 ED E 20	38.0	
								38.0		38.0							Mn			
								29.6		29.6							Mmax			
																	Mo	142 UD E 20		38.0
																	Mn			
																	Mmax			
																	Mo	142 UD C 30		25.0
								25.0		25.0							Mn			
								18.4		18.4							Mmax			
								61.4		74.9							Mo	142 UD C 30	25.0	
																	Mn			
																	Mmax			
																	Mo	142 ED D 30	31.5	
																	Mn			
																	Mmax			
																	Mo	142 UD D 30		31.5
																	Mn			
																	Mmax			
																	Mo	142 UD E 30		38.0
																	Mn			
																	Mmax			
																	Mo	142 UD E 30	38.0	
																	Mn			
																	Mmax			
																	Mo	142 UD E 30	38.0	
																	Mn			
																	Mmax			

190 hd

Drive part number				M700-04200185A	M700-04400150A	M700-04400172A	M700-05200250A	M700-05400270A			M700-05400300A			M700-06200330A	M700-06200440A		M700-06400350A		M700-06400420A	M700-07200610A		
Drive switching frequency				4	3	4	12	8	6	4	3	8	6	4	12	8	12	8	12	8	12	
Rated drive current				18.5	15.0	17.2	21.5	24.8	17.6	20.3	23.7	25.4	21.0	24.0	27.9	32.0	33.0	40.0	30.0	30.0	61.0	
Drive output maximal current				37.0	30.0	34.4	50.0	50.0	54.0	54.0	54.0	54.0	66.0	66.0	66.0	66.0	88.0	88.0	70.0	70.0	84.0	122.0
Rated motor speed	Motor stall torque	Motor type	Combined drive and motor performance																			
1000	52.0	190 ED C 10	Mo	49.4			52.0							52.0								
			Mn	46.6			49.0								49.0							
			Mmax	103.6			140.0									156.0						
	62.0	190 ED D 10	Mo				62.0							62.0	62.0							
			Mn				56.5								56.5	56.5						
			Mmax				140.0								184.8	186.0						
	85.0	190 ED F 10	Mo												85.0	85.0						85.0
			Mn												77.5	77.5						77.5
			Mmax												184.8	246.4						255.0
1500	52.0	190 UD C 15	Mo		46.8	49.4		52.0														
			Mn		41.6	43.9		46.2														
			Mmax		96.0	110.1		156.0														
	62.0	190 UD D 15	Mo					62.0			62.0											
			Mn					52.2			52.2											
			Mmax					172.8			186.0											
	85.0	190 UD F 15	Mo							76.5			80.8						85.0	85.0		
			Mn							61.7			65.1						68.5	68.5		
			Mmax							172.8			192.0						224.0	255.0		
2000	52.0	190 ED C 20	Mo												52.0						52.0	
			Mn												42.5							42.5
			Mmax												123.2							156.0
		190 UD C 20	Mo						49.4			52.0						52.0				
			Mn						40.4			42.5						42.5				
			Mmax						129.6			144.0						156.0				

Key

Mo = stall torque

Mn = rated torque

Mmax = maximum torque

075 E3

Drive part number				DSTI 201 1Ph	DSTI 201 3Ph	DSTI 202 1Ph	DSTI 202 3Ph	DSTI 203 1Ph	DSTI 203 3Ph	DSTI 204 1Ph	DSTI 204 3Ph	M700-03200050 A	M700-03200066 A	M700-03200080 A	M700-03200106 A	M700-04200137 A	M700-04200185 A				
Drive switching frequency				12			6		12			8		12		8		12			
Rated drive current				1.1	1.7	2.4	3.8	2.9	5.4	4.7	7.6	5.0	6.6	8.0	8.8	10.6	13.7	17.6			
Drive output maximal current				1.8	4.3	4.0	9.5	9.5	4.8	13.5	7.8	19.0	10.0	10.0	13.2	16.0	21.2	21.2	27.4	37.0	
Rated motor speed	Motor stall torque	Motor type	Combined drive and motor performance																		
2000	1.4	075 E3 A 20	Mo	1.4	1.4	1.4						1.4									
			Mn	1.3	1.3	1.3							1.3								
			Mmax	3.1	4.3	4.3							4.3								
	2.7	075 E3 B 20	Mo			2.7	2.7		2.7				2.7								
			Mn			2.5	2.5	2.5					2.5								
			Mmax			6.7	8.0	8.0					8.0								
	3.7	075 E3 C 20	Mo				3.7	3.7		3.7			3.7								
			Mn				3.5	3.5	3.5	3.5			3.5								
			Mmax				11.2	8.1	11.2	11.2			11.2								
	4.7	075 E3 D 20	Mo				4.7			4.7			4.7	4.7							
			Mn				4.5			4.5			4.5	4.5							
			Mmax				14.0			13.2			14.0	14.0							
3000	1.4	075 E3 A 30	Mo		1.4	1.4						1.4									
			Mn		1.3	1.3						1.3									
			Mmax		4.3	4.3						4.3									
	2.7	075 E3 B 30	Mo				2.7		2.7		2.7		2.7								
			Mn				2.3	2.3	2.3	2.3			2.3								
			Mmax				8.0	5.4	8.0	8.0			8.0								
	3.7	075 E3 C 30	Mo					3.5		3.7	3.7		3.7		3.7						
			Mn					3.1	3.3	3.3	3.3		3.3		3.3						
			Mmax					10.6	11.2	8.7	9.3		9.3		11.2						
	4.7	075 E3 D 30	Mo						4.7				4.6	4.7	4.7						
			Mn						4.2				4.1	4.2	4.2						
			Mmax						14.0				9.3	12.3	14.0						
4000	1.4	075 E3 A 40	Mo			1.4	1.4		1.4		1.4										
			Mn			1.2	1.2	1.2	1.2		1.2		1.2								
			Mmax			3.4	4.3	4.1	4.3	4.3		4.3									
	2.7	075 E3 B 40	Mo				2.7				2.7		2.7		2.7						
			Mn				2.1				2.1		2.1		2.1						
			Mmax				8.0				6.6		7.0		8.0						
	3.7	075 E3 C 40	Mo							3.7				3.7	3.7						
			Mn							2.8				2.8	2.8						
			Mmax							11.2				9.2	11.2						
	4.7	075 E3 D 40	Mo									4.7			4.7	4.7					
			Mn									3.8			3.8	3.8					
			Mmax									14.0			11.2	14.0					
6000	1.4	075 E3 A 60	Mo				1.4			1.4		1.4									
			Mn				1.1			1.1		1.1									
			Mmax				4.3			4.3		4.3									
	2.7	075 E3 B 60	Mo								2.7		2.7	2.7	2.7						
			Mn								1.9		1.9	1.9	1.9						
			Mmax								8.0		6.2	7.5	8.0						
	3.7	075 E3 C 60	Mo											3.7	3.7		3.7				
			Mn											2.8	2.8		2.8				
			Mmax											7.5	10.0		11.2				
	4.7	075 E3 D 60	Mo														4.7	4.7	4.7		
			Mn														3.4	3.4	3.4		
			Mmax														10.0	12.9	14.0		

Key

Mo = stall torque

Mn = rated torque

Mmax = maximum torque

095 E3

Drive part number				DST1201 3Ph	DST1202 1Ph	DST1202 3Ph	DST1203 1Ph	DST1203 3Ph		DST1204 1Ph		DST1204 3Ph	M700-03200050 A	M700-03200066 A	M700-03200080 A			
Drive switching frequency				8	12				6	12	8	12	3	12	8	12	6	
Rated drive current				1.7	2.4	3.8	2.9	5.4	5.4	4.7	4.7	7.6	5.0	5.0	6.6	6.6	8.0	8.0
Drive output maximal current				5.1	4.8	11.4	5.8	16.2	16.2	9.4	9.4	22.8	10.0	10.0	13.2	13.2	16.0	16.0
Rated motor speed	Motor stall torque	Motor type	Combined drive and motor performance															
2000	2.5	095 E3 A 20	Mo	2.4	2.5	2.5	2.5					2.5						
			Mn	2.3	2.4	2.4	2.4					2.4						
			Mmax	7.1	6.7	7.4	7.4					7.4						
	4.5	095 E3 B 20	Mo			4.5				4.5			4.5					
			Mn			4.3				4.3			4.3					
			Mmax			13.5				13.2			13.5					
	6.3	095 E3 C 20	Mo					6.3		6.3			6.3		6.3		6.3	
			Mn					5.9		5.9			5.9		5.9		5.9	
			Mmax					18.9		13.2			14.0		18.5		18.9	
	7.9	095 E3 D 20	Mo					7.4				7.9		7.0	7.9		7.9	
			Mn					6.8				7.3		6.4	7.3		7.3	
			Mmax					22.7				23.7		14.0	18.5		22.4	
9.3	095 E3 E 20	Mo									9.3				9.0	9.3		
		Mn									8.5			8.2	8.5			
		Mmax									27.8			18.5	22.4			
3000	2.5	095 E3 A 30	Mo			2.5	2.5		2.5			2.5						
			Mn			2.3	2.3		2.3		2.3							
			Mmax			7.4	5.4		7.4		7.4							
	4.5	095 E3 B 30	Mo					4.5			4.4		4.5		4.5		4.5	
			Mn					4.1			4.0		4.1		4.1		4.1	
			Mmax					13.5			8.7		9.3		12.3		13.5	
	6.3	095 E3 C 30	Mo									6.3				6.1	6.3	
			Mn									5.6			5.4	5.6		
			Mmax									18.9			12.3	14.9		
	7.9	095 E3 D 30	Mo															7.4
			Mn															6.4
			Mmax															14.9
9.3	095 E3 E 30	Mo																
		Mn																
		Mmax																
4000	2.5	095 E3 A 40	Mo			2.5			2.5			2.5		2.5				
			Mn			2.3			2.3		2.3		2.3		2.3			
			Mmax			7.4			6.6			7.0		7.4		7.4		
	4.5	095 E3 B 40	Mo									4.5		4.5		4.5		
			Mn									3.8		3.8		3.8		
			Mmax									13.5		9.2		11.2		
	6.3	095 E3 C 40	Mo												9.2			
			Mn															
			Mmax															
	7.9	095 E3 D 40	Mo															
			Mn															
			Mmax															
9.3	095 E3 E 40	Mo																
		Mn																
		Mmax																
6000	2.5	095 E3 A 60	Mo				2.5							2.5		2.5		
			Mn				2.0						2.0		2.0			
			Mmax				7.4						6.2		7.4			
	4.5	095 E3 B 60	Mo															
			Mn															
			Mmax															
6.3	095 E3 C 60	Mo																
		Mn																
		Mmax																

M700-03200106A		M700-04200137A		M700-04200185A		M700-05200250A		Drive part number								
12		8		12				Drive switching frequency								
8.8		10.6		13.7		17.6		21.5		Rated drive current						
21.2		21.2		27.4		37.0		50.0		Drive output maximal current						
										Combined drive and motor performance		Motor type	Motor stall torque	Rated motor speed		
										Mo		095 E3 A 20	2.5	2000		
										Mn						
										Mmax						
										Mo		095 E3 B 20	4.5		2000	
										Mn						
										Mmax						
										Mo		095 E3 C 20	6.3			2000
										Mn						
										Mmax						
7.9										Mo		095 E3 D 20	7.9	2000		
7.3										Mn						
23.7										Mmax						
9.3										Mo		095 E3 E 20	9.3		2000	
8.5										Mn						
27.8										Mmax						
										Mo		095 E3 A 30	2.5			3000
										Mn						
										Mmax						
										Mo		095 E3 B 30	4.5	3000		
										Mn						
										Mmax						
6.3										Mo		095 E3 C 30	6.3		3000	
5.6										Mn						
18.9										Mmax						
7.9				7.9						Mo		095 E3 D 30	7.9			3000
6.9				6.9						Mn						
19.7				23.7						Mmax						
		9.0		9.3		9.3				Mo		095 E3 E 30	9.3	3000		
		8.0		8.2		8.2				Mn						
		19.7		25.5		27.8				Mmax						
										Mo		095 E3 A 40	2.5		4000	
										Mn						
										Mmax						
4.5										Mo		095 E3 B 40	4.5			4000
3.8										Mn						
13.5										Mmax						
		6.3		6.3						Mo		095 E3 C 40	6.3	4000		
		5.3		5.3						Mn						
		14.8		18.9						Mmax						
				7.9		7.9				Mo		095 E3 D 40	7.9		4000	
				6.4		6.4				Mn						
				19.2		23.7				Mmax						
				9.3		9.3		9.3		Mo		095 E3 E 40	9.3			4000
				7.4		7.4		7.4		Mn						
				19.2		25.9		27.8		Mmax						
										Mo		095 E3 A 60	2.5	6000		
										Mn						
										Mmax						
4.5		4.5		4.5						Mo		095 E3 B 60	4.5		6000	
3.2		3.2		3.2						Mn						
10.0		12.9		13.5						Mmax						
		6.3		6.3		6.3				Mo		095 E3 C 60	6.3			6000
		4.2		4.2		4.2				Mn						
		12.9		17.4		18.9				Mmax						

Key

Mo = stall torque

Mn = rated torque

Mmax = maximum torque



115 E3

Drive part number				DST1202 3Ph	DST1203 1Ph	DST1203 3Ph	DST1204 1Ph	DST1204 3Ph			M700-03200050 A	M700-03200066 A	M700-03200080 A	M700-03200106 A					
Drive switching frequency				12				8	6	12	6	12			8	6	4		
Rated drive current				3.8	2.9	5.4	4.7	7.6	7.6	7.6	5.0	5.0	6.6	8.0	8.8	10.6	10.6	10.6	
Drive output maximal current				11.4	5.8	16.2	9.4	22.8	22.8	22.8	10.0	10.0	13.2	16.0	21.2	21.2	21.2	21.2	
Rated motor speed	Motor stall torque	Motor type	Combined drive and motor performance																
2000	3.9	115 E3 A 20	Mo	3.9	3.9		3.9				3.9								
			Mn	3.7	3.7		3.7				3.7								
			Mmax	11.7	8.1		11.7					11.7							
	7.4	115 E3 B 20	Mo			7.4						6.9	7.4	7.4					
			Mn			7.3						6.8	7.3	7.3					
			Mmax			22.2						14.0	18.5	22.2					
	10.8	115 E3 C 20	Mo						10.5					10.8	10.8				
			Mn						9.8					10.1	10.1				
			Mmax						31.9					22.4	29.7				
	13.7	115 E3 D 20	Mo													13.0			
			Mn													11.3			
			Mmax													29.7			
16.0	115 E3 E 20	Mo															14.4		
		Mn															12.7		
		Mmax																29.7	
3000	3.9	115 E3 A 30	Mo			3.9	3.9				3.9		3.9						
			Mn			3.5	3.5				3.5		3.5						
			Mmax			11.7	8.7					9.3		11.7					
	7.4	115 E3 B 30	Mo							6.9				7.4	7.4				
			Mn							6.2				6.7	6.7				
			Mmax							21.2				14.9	19.7				
	10.8	115 E3 C 30	Mo															9.8	
			Mn															8.6	
			Mmax																19.7
	13.7	115 E3 D 30	Mo																
			Mn																
			Mmax																
16.0	115 E3 E 30	Mo																	
		Mn																	
		Mmax																	
4000	3.9	115 E3 A 40	Mo					3.9				3.9	3.9	3.9					
			Mn					3.0				3.0	3.0	3.0					
			Mmax					11.7					9.2	11.2	11.7				
	7.4	115 E3 B 40	Mo													7.4			
			Mn													5.8			
			Mmax													14.8			
	10.8	115 E3 C 40	Mo																
			Mn																
			Mmax																
	13.7	115 E3 D 40	Mo																
			Mn																
			Mmax																
16.0	115 E3 E 40	Mo																	
		Mn																	
		Mmax																	
6000	3.9	115 E3 A 60	Mo												3.9				
			Mn												2.7				
			Mmax													10.0			
	7.4	115 E3 B 60	Mo																
			Mn																
			Mmax																

M700-04200137A		M700-04200185A		M700-05200250A		M700-06200330A		M700-06200440A		Drive part number							
12		6		12		8		12		Drive switching frequency							
13.7		13.7		17.6		21.5		24.8		32.0		33.0		Rated drive current			
27.4		27.4		37.0		50.0		50.0		66.0		88.0		Drive output maximal current			
										Combined drive and motor performance	Motor type	Motor stall torque	Rated motor speed				
										Mo	115 E3 A 20	3.9	2000				
										Mn							
										Mmax							
										Mo	115 E3 B 20	7.4					
										Mn							
										Mmax							
10.8										Mo	115 E3 C 20	10.8					
10.1										Mn							
32.4										Mmax							
										Mo	115 E3 D 20	13.7					
13.7										Mn							
11.9										Mmax							
11.9										Mo	115 E3 E 20	16.0					
38.4										Mn							
16.0										Mmax							
14.1										Mo	115 E3 A 30	3000					
38.4										Mn							
										Mmax							
										Mo	115 E3 B 30		7.4				
7.4										Mn							
6.7										Mmax							
22.2										Mo	115 E3 C 30		10.8				
10.8										Mn							
9.5										Mmax							
25.5										Mo	115 E3 D 30	13.7					
12.3										Mn							
10.1										Mmax							
10.8										Mo	115 E3 E 30	16.0					
9.5										Mn							
32.4										Mmax							
12.3										Mo	115 E3 A 40	4000					
10.1										Mn							
25.5										Mmax							
16.0										Mo	115 E3 B 40		7.4				
12.7										Mn							
34.4										Mmax							
10.8										Mo	115 E3 C 40		10.8				
7.4										Mn							
5.8										Mmax							
19.2										Mo	115 E3 D 40	13.7					
22.2										Mn							
10.8										Mmax							
7.5										Mo	115 E3 E 40	16.0					
7.5										Mn							
25.9										Mmax							
13.7										Mo	115 E3 A 60	6000					
8.3										Mn							
35.0										Mmax							
16.0										Mo	115 E3 B 60		7.4				
8.8										Mn							
35.0										Mmax							
16.0										Mo	115 E3 C 60		10.8				
8.8										Mn							
46.2										Mmax							
16.0										Mo	115 E3 D 60	13.7					
8.8										Mn							
48.0										Mmax							
3.9										Mo	115 E3 E 60	16.0					
2.7										Mn							
11.7										Mmax							
										Mo	115 E3 A 80	3.9					
7.4										Mn							
5.0										Mmax							
17.4										Mo	115 E3 B 80	7.4					
7.4										Mn							
22.2										Mmax							

Key

Mo = stall torque

Mn = rated torque

Mmax = maximum torque



142 E3

Drive part number				DSTI 203 3Ph	DSTI 204 1Ph	DSTI 204 3Ph		M700-03200050 A	M700-03200066A	M700-03200080 A	M700-03200106A			M700-04200137A				
Drive switching frequency				12		6		12	8	12	8	6	3	12	6			
Rated drive current				5.4	4.7	7.6	7.6	5.0	6.6	6.6	8.0	8.8	10.6	10.6	10.6	13.7	13.7	
Drive output maximal current				16.2	9.4	22.8	22.8	10.0	13.2	13.2	16.0	21.2	21.2	21.2	21.2	27.4	27.4	
Rated motor speed	Motor stall torque	Motor type	Combined drive and motor performance															
2000	6.2	142 E3 A 20	Mo	6.2	6.2			6.2	6.2		6.2							
			Mn	5.9	5.9			5.9	5.9		5.9							
			Mmax	18.6	13.2			14.0	18.5		18.6							
	11.0	142 E3 B 20	Mo				10.3					11.0					11.0	
			Mn				9.8					10.4	10.4				10.4	
			Mmax				31.9					22.4	29.7				33.0	
	15.7	142 E3 C 20	Mo											14.8			15.7	
			Mn											13.8			14.7	
			Mmax											29.7			38.4	
	20.5	142 E3 D 20	Mo															18.2
			Mn															16.5
			Mmax															
25.0	142 E3 E 20	Mo																
		Mn																
		Mmax																
3000	6.2	142 E3 A 30	Mo			6.2				6.0	6.2	6.2						
			Mn			5.5				5.3	5.5	5.5						
			Mmax			18.6					12.3	14.9	18.6					
	11.0	142 E3 B 30	Mo												9.6		11.0	
			Mn												8.3		9.5	
			Mmax												19.7		25.5	
	15.7	142 E3 C 30	Mo															
			Mn															
			Mmax															
	20.5	142 E3 D 30	Mo															
			Mn															
			Mmax															
25.0	142 E3 E 30	Mo																
		Mn																
		Mmax																
4000	6.2	142 E3 A 40	Mo									6.2				6.2		
			Mn									4.1				4.1		
			Mmax										14.8				18.6	
	11.0	142 E3 B 40	Mo															
			Mn															
			Mmax															
	15.7	142 E3 C 40	Mo															
			Mn															
			Mmax															
	20.5	142 E3 D 40	Mo															
			Mn															
			Mmax															
25.0	142 E3 E 40	Mo																
		Mn																
		Mmax																
6000	6.2	142 E3 D 60	Mo														6.2	
			Mn														3.2	
			Mmax															12.9

190 E3

Drive part number				M700-03200080A	M700-03200106A	M700-04200137A	M700-04200185A	M700-05200250A	M700-06200330A	M700-06200440A								
Drive switching frequency				6		12	6	12	8	6	12	8	6	12	8	6		
Rated drive current				8.0	8.8	13.7	17.6	18.5	21.5	24.8	25.0	32.0	33.0	33.0	33.0	40.0	44.0	
Drive output maximal current				16.0	21.2	27.4	37.0	37.0	50.0	50.0	50.0	66.0	66.0	66.0	88.0	88.0	88.0	
Rated motor speed	Motor stall torque	Motor type	Combined drive and motor performance															
2000	11.3	190 E3 A 20	Mo	11.1	11.3	11.3												
			Mn	10.7	10.8	10.8												
			Mmax	22.4	29.7	33.8												
	22.5	190 E3 B 20	Mo				22.5		22.5									
			Mn				20.6		20.6									
			Mmax				51.8		67.5									
	33.5	190 E3 C 20	Mo					25.8		30.2			33.5				33.5	
			Mn					22.6		26.5			29.4				29.4	
			Mmax					51.8		70.0			92.4				100.5	
	44.5	190 E3 D 20	Mo								34.3						44.5	
			Mn								29.2						37.9	
			Mmax									70.0					92.4	
	54.0	190 E3 E 20	Mo												41.6		48.6	
			Mn												34.1		39.9	
			Mmax												92.4		123.2	
	63.0	190 E3 F 20	Mo															48.5
			Mn															38.9
			Mmax															
	71.0	190 E3 G 20	Mo															54.7
			Mn															41.6
			Mmax															
	77.0	190 E3 H 20	Mo															59.3
			Mn															43.1
			Mmax															
3000	11.3	190 E3 A 30	Mo			11.3	11.3											
			Mn			10.3	10.3											
			Mmax			25.5	33.8											
	22.5	190 E3 B 30	Mo						22.5		22.5						22.5	
			Mn							19.4		19.4					19.4	
			Mmax							46.5		61.4					67.5	
	33.5	190 E3 C 30	Mo									30.2					30.2	
			Mn									23.9				23.9		
			Mmax										61.4				81.8	
	44.5	190 E3 D 30	Mo															34.3
			Mn															25.6
			Mmax															
	54.0	190 E3 E 30	Mo															
			Mn															
			Mmax															
	63.0	190 E3 F 30	Mo															
			Mn															
			Mmax															
	71.0	190 E3 G 30	Mo															
			Mn															
			Mmax															
	77.0	190 E3 H 30	Mo															
			Mn															
			Mmax															
4000	11.3	190 E3 A 40	Mo				11.3		11.3									
			Mn				8.2		8.2									
			Mmax				25.9		33.8									
	22.5	190 E3 B 40	Mo									22.5				22.5		
			Mn									18.2			18.2			
			Mmax									46.2			61.6			
	33.5	190 E3 C 40	Mo															
			Mn															
			Mmax															
	44.5	190 E3 D 40	Mo															
			Mn															
			Mmax															

075 U3

Drive part number				DST1401 3Ph	DST1402 3Ph	DST1403 3Ph		DST1404 3Ph	M700-03400025A	M700-03400031A	M700-03400045A	M700-03400062A		M700-03400078A		M700-03400100 A			
Drive switching frequency				8	6	8		12				8	6	12	8				
Rated drive current				1.5	2.7	4.0	5.9	2.5	3.1	4.5		5.8	6.2	5.7	7.6	7.7			
Drive output maximal current				4.5	4.5	8.1	12.0	17.7	5.0	6.2	9.0	12.4	12.4	12.4	15.6	15.6	20.0	20.0	
Rated motor speed	Motor stall torque	Motor type	Combined drive and motor performance																
2000	1.4	075 U3 A 20	Mo	1.4				1.4											
			Mn	1.3				1.3											
			Mmax	4.3				4.3											
	2.7	075 U3 B 20	Mo	2.6				2.7											
			Mn	2.5				2.5											
			Mmax	8.0				8.0											
	3.7	075 U3 C 20	Mo		3.5	3.7		3.7											
			Mn		3.3	3.4		3.5											
			Mmax		10.8	11.2		11.2											
	4.7	075 U3 D 20	Mo			4.6		4.7	4.7										
			Mn			4.4		4.5	4.5										
			Mmax			14.0		12.0	14.0										
3000	1.4	075 U3 A 30	Mo	1.4				1.4											
			Mn	1.3				1.3											
			Mmax	4.3				4.3											
	2.7	075 U3 B 30	Mo			2.6		2.7											
			Mn			2.3		2.3											
			Mmax			8.0		8.0											
	3.7	075 U3 C 30	Mo			3.7		3.7	3.7	3.7									
			Mn			3.2		3.3	3.3	3.3									
			Mmax			11.2		8.0	9.9	11.2									
	4.7	075 U3 D 30	Mo			4.6		4.7	4.7										
			Mn			4.1		4.2	4.2										
			Mmax			14.0		9.9	14.0										
4000	1.4	075 U3 A 40	Mo	1.4				1.4											
			Mn	1.2				1.2											
			Mmax	4.3				4.3											
	2.7	075 U3 B 40	Mo			2.7		2.7	2.7	2.7									
			Mn			2.1		2.1	2.1	2.1									
			Mmax			8.0		6.0	7.4	8.0									
	3.7	075 U3 C 40	Mo			3.7		3.7	3.7	3.7									
			Mn			2.8		2.8	2.8	2.8									
			Mmax			11.2		7.4	10.8	11.2									
	4.7	075 U3 D 40	Mo			4.7		4.7	4.7	4.7									
			Mn			3.8		3.8	3.8	3.8									
			Mmax			14.0		10.8	14.0										
6000	1.4	075 U3 A 60	Mo		1.4		1.4	1.4											
			Mn		1.1		1.1	1.1											
			Mmax		4.3		4.0	4.3											
	2.7	075 U3 B 60	Mo			2.7		2.7	2.7										
			Mn			1.9		1.9	1.9										
			Mmax			8.0		7.2	8.0										
	3.7	075 U3 C 60	Mo			3.7		3.7	3.7				3.7		3.7				
			Mn			2.8		2.8	2.8				2.8		2.8				
			Mmax			11.2		9.9		9.9				11.2					
	4.7	075 U3 D 60	Mo			4.7		4.7	4.7				4.7		4.7	4.7	4.7		
			Mn			3.4		3.4	3.4				3.4		3.4	3.4	3.4		
			Mmax			14.0		14.0		9.9			12.5		14.0	14.0	14.0		

Key

Mo = stall torque

Mn = rated torque

Mmax = maximum torque



Case Study 4 - Servo motors and drives at the heart of printing, converting and finishing machines from Rotary Logic Systems

Rotary Logic Systems creates bespoke systems for various high speed printing applications.

The challenge

Rotary Logic Systems supplies both stand-alone machines and modules to suit all applications in the converting and finishing industries. The company needed a servo solution for a six line, multi-stage anti-counterfeit machine for packaging, incorporating high precision application of a hot-foil hologram. Alan Chandler, the company's director, says: "We need drives that are flexible in operation, straight forward to program and with very fast response– that's why we use mainly Digitax ST Plus servo-drives from Control Techniques".

The solution

The lines each comprise unwind and in-feed, foiling, flying head die-cutting, flexographic printing, out-feed and rewind. Digitax ST Plus servo drives twinned with Unimotor fm servo motors control the feeds and various other processes.

The Benefits

- Flexible operation
- Straightforward programming
- Very fast response



095 U3

Drive part number				DSTI 401 3Ph	DSTI 402 3Ph		DSTI 403 3Ph	DSTI 404 3Ph	DSTI 405 3Ph	M700-03400025A			M700-03400031A		M700-03400045A															
Drive switching frequency				8		6		8		12			6		3															
Rated drive current				1.5		2.7		4.0		5.9		8.0		2.5			3.1		3.1		4.5									
Drive output maximal current				4.5		8.1		8.1		12.0		17.7		24.0		5.0			5.0		5.0		6.2		6.2		9.0		9.0	
Rated motor speed	Motor stall torque	Motor type	Combined drive and motor performance																											
2000	2.5	095 U3 A 20	Mo	2.4										2.5																
			Mn	2.3										2.4																
			Mmax	7.4										7.4																
	4.5	095 U3 B 20	Mo	4.4										4.5		4.5														
			Mn	4.2										4.3		4.3														
			Mmax	13.5										12.0		13.5														
	6.3	095 U3 C 20	Mo	6.1										5.9		6.3						6.3								
			Mn	5.7										5.5		5.9						5.9								
			Mmax	18.9										12.0		14.9						18.9								
	7.9	095 U3 D 20	Mo			7.7												7.4				7.9								
			Mn			7.1												6.8				7.3								
			Mmax			23.7												14.9				21.6								
9.3	095 U3 E 20	Mo			9.0																9.3									
		Mn			8.2																8.5									
		Mmax			27.8																21.6									
3000	2.5	095 U3 A 30	Mo	2.4		2.4								2.5																
			Mn	2.2		2.2								2.3																
			Mmax	7.2		7.4								7.4																
	4.5	095 U3 B 30	Mo			4.2		4.4								4.0		4.5				4.5								
			Mn			3.8		4.0								3.6		4.1				4.1								
			Mmax			13.0		13.5								8.0		9.9				13.5								
	6.3	095 U3 C 30	Mo			6.1																6.3								
			Mn			5.4																5.6								
			Mmax			18.9																14.4								
	7.9	095 U3 D 30	Mo					7.7																		7.2				
			Mn					6.7																		6.3				
			Mmax					23.7																		14.4				
9.3	095 U3 E 30	Mo					9.0																							
		Mn					8.0																							
		Mmax					27.8																							
4000	2.5	095 U3 A 40	Mo	2.5										2.5		2.5														
			Mn	2.3										2.3		2.3														
			Mmax	7.4										6.0		7.4														
	4.5	095 U3 B 40	Mo					4.5														4.5								
			Mn					3.8														3.8								
			Mmax					13.5														10.8								
	6.3	095 U3 C 40	Mo					6.3																						
			Mn					5.3																						
			Mmax					18.9																						
	7.9	095 U3 D 40	Mo							7.9																				
			Mn							6.4																				
			Mmax							23.7																				
9.3	095 U3 E 40	Mo							9.3																					
		Mn							7.4																					
		Mmax							27.8																					
6000	2.5	095 U3 A 60	Mo			2.5										2.5				2.5										
			Mn			2.0										2.0				2.0										
			Mmax			7.4										5.0				7.2										
	4.5	095 U3 B 60	Mo					4.5																						
			Mn					3.2																						
			Mmax					13.5																						
6.3	095 U3 C 60	Mo							6.3																					
		Mn							4.2																					
		Mmax							18.9																					

M700-03400062A		M700-03400078A			M700-03400100 A			M700-04400150 A		Drive part number
12	8	12	8	6	12	8	6	12	12	Drive switching frequency
4.5	5.8	5.7	7.6	7.8	5.7	7.7	9.2	11.5	11.5	Rated drive current
12.4	12.4	15.6	15.6	15.6	20.0	20.0	20.0	30.0	30.0	Drive output maximal current
										Combined drive and motor performance
										Motor type
										Motor stall torque
										Rated motor speed
										Mo
										Mn
										Mmax
										Mo
										Mn
										Mmax
										Mo
										Mn
										Mmax
										Mo
										Mn
										Mmax
7.9										Mo
7.3										Mn
23.7										Mmax
9.3										Mo
8.5										Mn
27.8										Mmax
										Mo
										Mn
										Mmax
										Mo
										Mn
										Mmax
										Mo
										Mn
										Mmax
6.3										Mo
5.6										Mn
18.9										Mmax
	7.7	7.9								Mo
	6.7	6.9								Mn
	19.8	23.7								Mmax
	9.0		9.0			9.0		9.3		Mo
	8.0		8.0			8.0		8.2		Mn
	19.8		25.0			27.8		27.8		Mmax
										Mo
										Mn
										Mmax
										Mo
										Mn
										Mmax
4.5										Mo
3.8										Mn
13.5										Mmax
	6.3	6.3				6.3				Mo
	5.3	5.3				5.3				Mn
	14.9	18.7				18.9				Mmax
										Mo
										Mn
										Mmax
										Mo
										Mn
										Mmax
										Mo
										Mn
										Mmax
										Mo
										Mn
										Mmax
2.5										Mo
2.0										Mn
7.4										Mmax
	4.5	4.5				4.5				Mo
	3.2	3.2				3.2				Mn
	9.9	12.5				13.5				Mmax
										Mo
										Mn
										Mmax
										Mo
										Mn
										Mmax

Key

Mo = stall torque

Mn = rated torque

Mmax = maximum torque

115 U3

Drive part number				DSTI 402 3Ph	DSTI 403 3Ph	DSTI 404 3Ph	DSTI 405 3Ph	M700-03400025A	M700-03400031A	M700-03400045A	M700-03400062A				M700-03400078A						
Drive switching frequency				8			6		12			8		12		8		6			
Rated drive current				2.7	4.0	5.9	8.0		2.5	3.1	4.5		5.8		6.2		5.7	7.6	7.8		
Drive output maximal current				8.1	12.0	17.7	24.0	24.0	5.0	6.2	9.0	9.0	12.4	12.4	12.4	12.4	15.6	15.6	15.6		
Rated motor speed	Motor stall torque	Motor type	Combined drive and motor performance																		
2000	3.9	115 U3 A 20	Mo	3.8				3.9													
			Mn	3.6				3.7													
			Mmax	11.7				11.7													
	7.4	115 U3 B 20	Mo		7.2				7.4	7.4		7.4									
			Mn		7.1			7.3	7.3		7.3										
			Mmax		22.2			14.9	21.6		22.2										
	10.8	115 U3 C 20	Mo			10.5					10.5		10.5					10.8			
			Mn			9.8					9.8		9.8					10.1			
			Mmax			32.4					21.6		29.8				32.4				
	13.7	115 U3 D 20	Mo			13.0							13.0				13.7				
			Mn			11.3							11.3				11.9				
			Mmax			41.0							29.8				37.4				
16.0	115 U3 E 20	Mo			15.2							14.4				15.2					
		Mn			13.4							12.7				13.4					
		Mmax			48.0							29.8				37.4					
3000	3.9	115 U3 A 30	Mo	3.8				3.9	3.9	3.9											
			Mn	3.4				3.5	3.5	3.5											
			Mmax	11.7				8.0	9.9	11.7											
	7.4	115 U3 B 30	Mo			7.2					7.2		7.2				7.4				
			Mn			6.5					6.5		6.5				6.7				
			Mmax			22.2					14.4		19.8				22.2				
	10.8	115 U3 C 30	Mo			10.5										9.8		10.5			
			Mn			9.2										8.6		9.2			
			Mmax			32.4										19.8		25.0			
	13.7	115 U3 D 30	Mo				12.3													12.3	
			Mn				10.1													10.1	
			Mmax				38.4													25.0	
16.0	115 U3 E 30	Mo																			
		Mn																			
		Mmax																			
4000	3.9	115 U3 A 40	Mo		3.9					3.9		3.9									
			Mn		3.0					3.0		3.0									
			Mmax		11.7					10.8		11.7									
	7.4	115 U3 B 40	Mo			7.4							7.4				7.4				
			Mn			5.8							5.8				5.8				
			Mmax			22.2							14.9				18.7				
	10.8	115 U3 C 40	Mo																		
			Mn																		
			Mmax																		
	13.7	115 U3 D 40	Mo																		
			Mn																		
			Mmax																		
16.0	115 U3 E 40	Mo																			
		Mn																			
		Mmax																			
6000	3.9	115 U3 A 60	Mo			3.9						3.9				3.9					
			Mn			2.7						2.7				2.7					
			Mmax			11.7							9.9				11.7				
	7.4	115 U3 B 60	Mo																		
			Mn																		
			Mmax																		

M700-03400100 A					M700-04400150 A		M700-04400172 A		M700-05400270 A	Drive part number			
12	8	6	4	12	8	12	8	12	Drive switching frequency				
5.7	7.7	9.2	10.0	11.5	14.4	11.5	14.4	13.8	Rated drive current				
20.0	20.0	20.0	20.0	30.0	30.0	34.4	34.4	54.0	Drive output maximal current				
										Combined drive and motor performance	Motor type	Motor stall torque	Rated motor speed
										Mo	115 U3 A 20	3.9	2000
										Mn			
										Mmax			
										Mo	115 U3 B 20	7.4	
										Mn			
										Mmax			
										Mo	115 U3 C 20	10.8	
										Mn			
										Mmax			
13.7										Mo	115 U3 D 20	13.7	
11.9										Mn			
41.0										Mmax			
										Mo	115 U3 E 20	16.0	
										Mn			
										Mmax			
										Mo	115 U3 A 30	3.9	
										Mn			
										Mmax			
										Mo	115 U3 B 30	7.4	
										Mn			
										Mmax			
										Mo	115 U3 C 30	10.8	
10.5										Mn			
9.2										Mmax			
32.0										Mo	115 U3 D 30	13.7	
										Mn			
										Mmax			
										Mo	115 U3 E 30	16.0	
										Mn			
										Mmax			
										Mo	115 U3 A 40	3.9	
										Mn			
										Mmax			
										Mo	115 U3 B 40	7.4	
7.4										Mn			
5.8										Mmax			
22.2										Mo	115 U3 C 40	10.8	
										Mn			
										Mmax			
										Mo	115 U3 D 40	13.7	
										Mn			
										Mmax			
										Mo	115 U3 E 40	16.0	
										Mn			
										Mmax			
										Mo	115 U3 A 60	3.9	
										Mn			
										Mmax			
										Mo	115 U3 B 60	7.4	
										Mn			
										Mmax			

Key

Mo = stall torque

Mn = rated torque

Mmax = maximum torque

142 U3

Drive part number				DST1402 3Ph	DST1403 3Ph	DST1404 3Ph	DST1405 3Ph		M700-03400025A	M700-03400031A	M700-03400045A	M700-03400062A			M700-03400078A						
Drive switching frequency				8	8	8	8	6	6	12	12	8	6	3	12	8	6				
Rated drive current				2.7	4.0	5.9	8.0	8.0	2.5	3.1	4.5	4.5	4.5	5.8	6.2	6.2	5.7	7.6	7.8		
Drive output maximal current				8.1	12.0	17.7	24.0	24.0	5.0	6.2	9.0	9.0	12.4	12.4	12.4	12.4	15.6	15.6	15.6		
Rated motor speed	Motor stall torque	Motor type	Combined drive and motor performance	Mo	6.0				5.8	6.2	6.2										
				Mn	5.7				5.6	5.9	5.9										
2000	6.2	142 U3 A 20	Mmax	18.6					12.0	14.9	18.6										
			11.0	142 U3 B 20	Mo			10.7					10.7		10.7			11.0			
					Mn			10.1					10.1	10.1				10.4			
	Mmax					33.0					21.6	29.8				33.0					
	15.7	142 U3 C 20	Mo				15.2							14.8			15.2				
			Mn				14.3							13.8			14.3				
			Mmax				47.1							29.8			37.4				
	20.5	142 U3 D 20	Mo					18.2											18.2		
			Mn					16.5											16.5		
			Mmax					57.6											37.4		
	25.0	142 U3 E 20	Mo																		
			Mn																		
Mmax																					
3000	6.2	142 U3 A 30	Mo		6.0						6.2		6.2								
			Mn		5.3						5.5	5.5									
			Mmax		18.6						14.4	18.6									
	11.0	142 U3 B 30	Mo				10.7								9.6		10.7				
			Mn				9.2								8.3		9.2				
			Mmax				33.0								19.8		25.0				
	15.7	142 U3 C 30	Mo																		
			Mn																		
			Mmax																		
	20.5	142 U3 D 30	Mo																		
			Mn																		
			Mmax																		
25.0	142 U3 E 30	Mo																			
		Mn																			
		Mmax																			
4000	6.2	142 U3 A 40	Mo			6.2							6.2		6.2						
			Mn			4.1							4.1		4.1						
			Mmax			18.6							14.9		18.6						
	11.0	142 U3 B 40	Mo																		
			Mn																		
			Mmax																		
	15.7	142 U3 C 40	Mo																		
			Mn																		
			Mmax																		
	20.5	142 U3 D 40	Mo																		
			Mn																		
			Mmax																		
25.0	142 U3 E 40	Mo																			
		Mn																			
		Mmax																			
6000	6.2	142 U3 A 60	Mo				6.2											6.2			
			Mn				3.2											3.2			
			Mmax				18.6												12.5		
	11.0	142 U3 B 60	Mo																		
			Mn																		
			Mmax																		

Key Mo = stall torque Mn = rated torque Mmax = maximum torque

190 U3

Drive part number				DST1404 3Ph	DST1405 3Ph	M700-03400062A	M700-03400078A	M700-03400100 A	M700-04400150 A	M700-04400172A	M700-05400270 A							
Drive switching frequency				8			12	8	4	12	8	6	8	6	8	6		
Rated drive current				5.9	8.0	5.8	5.7	7.6	7.7	10.0	11.5	14.4	15.0	14.4	16.1	17.6	20.3	
Drive output maximal current				17.7	24.0	12.4	15.6	15.6	20.0	20.0	30.0	30.0	30.0	34.4	34.4	54.0	54.0	
Rated motor speed	Motor stall torque	Motor type	Combined drive and motor performance															
2000	11.3	190 U3 A 20	Mo	11.3		11.3	11.3											
			Mn	10.8		10.8	10.8											
			Mmax	33.8		29.8	33.8											
	22.5	190 U3 B 20	Mo						22.3	22.5								
			Mn						20.4	20.6								
			Mmax						48.0	67.5								
	33.5	190 U3 C 20	Mo								30.2			30.2			30.2	
			Mn								26.5			26.5			26.5	
			Mmax								72.0			82.6			100.5	
	44.5	190 U3 D 20	Mo									34.3			34.3		40.1	
			Mn									29.2			29.2		34.1	
			Mmax									72.0			82.6		129.6	
	54.0	190 U3 E 20	Mo															41.6
			Mn															34.1
			Mmax															129.6
	63.0	190 U3 F 20	Mo															48.5
			Mn															38.9
			Mmax															129.6
	71.0	190 U3 G 20	Mo															
			Mn															
			Mmax															
	77.0	190 U3 H 20	Mo															
			Mn															
			Mmax															
3000	11.3	190 U3 A 30	Mo		11.3		11.3	11.3		11.3								
			Mn		10.3		10.3	10.3		10.3								
			Mmax		33.8		25.0	32.0		33.8								
	22.5	190 U3 B 30	Mo								22.5			22.5			22.5	
			Mn								19.4			19.4			19.4	
			Mmax								48.0			55.0			67.5	
	33.5	190 U3 C 30	Mo															25.8
			Mn															20.4
			Mmax															86.4
	44.5	190 U3 D 30	Mo															
			Mn															
			Mmax															
	54.0	190 U3 E 30	Mo															
			Mn															
			Mmax															
	63.0	190 U3 F 30	Mo															
			Mn															
			Mmax															
	71.0	190 U3 G 30	Mo															
			Mn															
			Mmax															
	77.0	190 U3 H 30	Mo															
			Mn															
			Mmax															
4000	11.3	190 U3 A 40	Mo						11.3	11.3								
			Mn						8.2	8.2								
			Mmax						24.0	33.8								
	22.5	190 U3 B 40	Mo															22.5
			Mn															18.2
			Mmax															64.8
	33.5	190 U3 C 40	Mo															
			Mn															
			Mmax															
	44.5	190 U3 D 40	Mo															
			Mn															
			Mmax															

Key Mo = stall torque Mn = rated torque Mmax = maximum torque

250 U3

Drive part number				M700-04400150A	M700-04400172A	M700-05400270 A			M700-05400300 A			M700-06400350 A			M700-06400420 A			
Drive switching frequency				3	6	8	6	4	6	4	3	12	8	6	4	8	6	4
Rated drive current				15.0	16.1	17.6	20.3	23.7	24.0	27.9	30.0	23.0	30.0	35.0		30.0	35.0	42.0
Drive output maximal current				30.0	34.4	54.0	54.0	54.0	60.0	60.0	60.0	70.0	70.0	70.0	70.0	84.0	84.0	84.0
Rated motor speed	Motor stall torque	Motor type	Combined drive and motor performance															
1000	92.0	250 U3 D 10	Mo	81.0	86.5	90.2						92.0						
			Mn	66.0	70.5	73.5						75.0						
			Mmax	162.0	185.8	276.0						276.0						
	116.0	250 U3 E 10	Mo			109.0		109.0				116.0						
			Mn			86.5		86.5				92.0						
			Mmax			291.6		324.0				348.0						
	136.0	250 U3 F 10	Mo				122.4	127.8				133.3			133.3			
			Mn				95.4	99.6				103.9			103.9			
			Mmax				291.6	324.0				378.0			408.0			
1500	92.0	250 U3 D 15	Mo			82.8		82.8				90.2			90.2			
			Mn			60.3		60.3			65.7			65.7				
			Mmax			194.4		216.0				252.0			276.0			
	116.0	250 U3 E 15	Mo						102.1			109.0			109.0			
			Mn						66.9			71.4			71.4			
			Mmax						216.0			252.0			302.4			
	136.0	250 U3 F 15	Mo										122.4			122.4		
			Mn										75.6			75.6		
			Mmax										252.0			302.4		
2000	92.0	250 U3 D 20	Mo						81.0			86.5			86.5			
			Mn						57.2			61.1			61.1			
			Mmax						162.0			189.0			226.8			
	116.0	250 U3 E 20	Mo														104.4	
			Mn														65.7	
			Mmax														226.8	
	136.0	250 U3 F 20	Mo															
			Mn															
			Mmax															
2500	92.0	250 U3 D 25	Mo														82.8	
			Mn														55.8	
			Mmax														176.4	
	116.0	250 U3 E 25	Mo															
			Mn															
			Mmax															
	136.0	250 U3 F 25	Mo															
			Mn															
			Mmax															

Key

Mo = stall torque

Mn = rated torque

Mmax = maximum torque

6 Motor and signal cables

Cables are an important part of a servo system installation. Not only must the noise immunity and integrity of the cabling and connectors be correct, but also SAFETY and EMC regulations must be complied with to ensure successful, reliable and fail safe operation. One of the most frequent problems experienced by motion systems engineers is incorrect connections of the motor to the drive.

Ready made cables from Control Techniques and Leroy-Somer allow system installers to avoid the intricate, time consuming assembly normally associated with connecting servo systems. Installation and set-up time are greatly reduced - there is no fiddling with wire connections and crimp tools, and no fault finding.

The cables are made to order in lengths from 1m to 100 m.

Power cable variants

- Phase conductors 1.0 mm² (10 A) to 25 mm² (70 A)
- With and without brake wire pairs
- Motor end connector
- Motor end ferrules for hybrid box
- Drive end is tailored to suit the drive and can have ferrules or ring terminals

Cable features

- PUR outer sheath for oil resistance and dynamic performance. The PUR jacket has excellent abrasion, chemical and ozone resistance along with low smoke and low halogen flame retardant construction suitable for internal and external industrial environments.
- PVC outer sheath for oil resistance and static performance.
- Complies with DESINA coding - Orange for power, Green for signal
- Power cable and plugs UL recognized
- Optimum noise immunity
- Encoder cable has low volt drop for long cable lengths and separately screened thermistor wires.
- No need for crimp and insertion / removal tools
- Production build gives quality and price benefits
- Power cables with and without brake wires
- Cable assembly type identification label
- Brake wires are separately shielded within the power cable

6.1 General Cable Specifications

	POWER		SIGNAL	
	PVC	PUR	PUR	PVC
Electrical	<ul style="list-style-type: none"> → Nominal voltage : 1,000 V UL Power cores U₀/U 0,6/1 kV Control cores U₀/U 300/500 V → Test voltage : 3 kV → Conductor resistance (at 20 °C) : according to class 6 VDE 0295, EN 60228 → Insulation resistance (at 20 °C) : > 20 MΩ x km 		<ul style="list-style-type: none"> → Nominal voltage : 1,000 V UL Maximum 350 V (VDE/DIN) → Test voltage : maximum 3 kV → Conductor resistance (at 20 °C) : according to class 6 VDE 0295, EN 60228 → Insulation resistance (at 20 °C) : > 20 MΩ x km → Mutual capacitance : core/core approx. 70 pF/m core/screen approx. 110 pF/m → Speed of propagation (Vp) : 5,05 ns/m (66 %) 	
Mechanical	<ul style="list-style-type: none"> → Minimum bending radius : 15 x outer diameter (fixed installation) 	<ul style="list-style-type: none"> → Minimum bending radius : 5 x outer diameter (fixed installation) → Minimum bending radius : 7.5 x outer diameter (dynamic installation) → Installation : cable into drag-chain → Maximum speed : 300 m/min → Maximum acceleration : 40 m/s² → Drag-chain length : maximum 15 m → Number of cycle : 5,000,000 		<ul style="list-style-type: none"> → Minimum bending radius : 15 x outer diameter (fixed installation)
Thermal	<ul style="list-style-type: none"> → Operating temperature range : -30 °C to +80 °C → Maximum according to UL : +80 °C 			
Chemical	<ul style="list-style-type: none"> → Oil resistance : according to UL1581 	<ul style="list-style-type: none"> → Oil resistance : according to EN 50363-10-2, OIL 80 °C UL758 		<ul style="list-style-type: none"> → Oil resistance : according to UL1581
Fire Behavior	<ul style="list-style-type: none"> → Flame retardant : according to EN60332-1 → Cable flame test : FT1 CSA C.22.2 n° 210 → Halogen-free : according to IEC 60754-1 			
Approvals	<ul style="list-style-type: none"> → Desina standard → UL/CSA AWM → EC low voltage directive 73/23/EEC and CE marking directive 93/68/EEC → UE directive 2002/95/CE restriction of the use of hazardous substance (RoHS) 			

6.2 Power cables (PUR & PVC)

6.2.1 Power cable construction

Phase & conductor size (current rating CEI EN 60204-1:2006-09 at 40 °C – installation method B2)	Power plug size	Plug current rating	Power no brake - number of cores x cross section (mm ²)	Power braked - number of cores x cross section (mm ²)	Nominal outer diameter (mm) no brake	Nominal outer diameter (mm) braked	Tolerance (mm)
1 mm ² (10,1 Amps)	Size 1	30 A	4G1	4G1+(2 X 0.5)	7,9	9,5	± 0,3
2,5 mm ² (17,4 Amps)	Size 1	30 A	4G2.5	4G2.5+(2 X 0.5)	11	12	± 0,3
4 mm ² (23 Amps)	Size 1	30 A	4G4	4G4+(2 X 1)	12,2	13,3	± 0,3
6 mm ² (30 Amps)	Size 1,5	53 A	4G6	4G6+(2 X 1)	14,5	15,5	± 0,4
10 mm ² (40 Amps)	Size 1,5	53 A	4G10	4G10+(2 X 1)	18,3	18,8	± 0,4
16 mm ² (54 Amps)	Size 1,5	70 A	4G16	4G16+(2 X 1)	21,4	21,6	± 0,5
25 mm ² (70 Amps)	n/a	n/a	4G25	4G25+(2 X 1)	26,5	26,9	± 0,5

6.2.2 Power cable codification

Field number

1	2	3	4	5	6	7	8	9	10	11	12
M	B	B	A	A	A	0	0	2	5	S	S

Cable type (field N° 1 & 2)

MB = power braked
4 w + 2 w + screen
MS = power 4 w + screen

Jacket type (field N° 3)

A = PVC fixed installation
B = PUR dynamic installation

Length metre () (field N° 7, 8, & 9 + 10)**

0010 = 1 metre
0025 = 2.5 metres
1,000 = 100 metres max
5,000 = 500 metres max cut end

Optional: Progressive alphanumeric code for custom special requests (field N° 11 & 12)

Phase & conductor size (field N° 4)	Drive end connection (*) (field N° 5)	Motor end Connection (field N° 6)
MS = Power NO brake or MB = power braked	A = Unidrive M size 3-4-5 / Unidrive SP size 0-1-2 / Digitax ULTRASONIC WELDING	A = 6 way power size 1 from 1 to 4 mm ² (no Speedtec conn.)
A = 1 mm ² or 1 mm ² + 0.5 mm ²	B = Unidrive M size 6 / Unidrive SP size 3 ring terminal M6	B = 6 way power size 1.5 53 Amps 4 mm ² (no Speedtec conn.)
B = 2.5 mm ² or 2.5 mm ² + 0.5 mm ²	C = Unidrive M size 7 ring terminal M8	C = 6 way power size 1.5 70 Amps from 6 to 16 mm ² (no Speedtec conn.)
C = 4 mm ² or 4 mm ² + 1 mm ²	D = Unidrive M size 8 ring terminal TBA	D = 75-250 Unimotor fm hybrid box ULTRASONIC WELDING
D = 6 mm ² or 6 mm ² + 1 mm ²	G = Unidrive SP size 4-5-6 ring terminal M10	S = Special
E = 10 mm ² or 10 mm ² + 1 mm ²	P = 6 way male plug	X = Cut end
F = 16 mm ² or 16 mm ² + 1 mm ²	S = Special	S = Special
G = 25 mm ² or 25 mm ² + 1 mm ²	X = Cut end	

(*) Terminal sizes by Unidrive M 700/701 user guide issue number 7 / Unidrive SP user guide issue number 13

(**) Length meter / cable requiring (cm) lengths will be rounded up to the next highest half metre; Eg. 2.1 will be charged as a 2.5 metre cable
Maximum cable assembly length 100 meters

6.3 Signal cables (PUR & PVC)

6.3.1 Signal cable construction

Code	Cable construction	Nominal outer diameter (mm)	Tolerance (mm)
Incremental Encoder (ABZ + UVW) & Sincos with EnDat	SI	$[(2 \times 0,34)E(St) + 6 \times 2 \times 0,25 + 1 \times 2 \times 0,50]ST \text{ mm}^2$	10
Resolver	SR	$[4 \times (2 \times 0,25) St]ST \text{ mm}^2$	8,5
Sincos with Hiperface	SS	$[4 \times (2 \times 0,15) St + 1 \times 2 \times 0,50] ST \text{ mm}^2$	8,9

6.3.2 Signal cable codification

Field number

1	2	3	4	5	6	7	8	9	10	11	12
S	I	B	A	A	A	0	0	2	5	S	S

Cable type (field N° 1 & 2)

SI = Incremental encoder & EnDat
 SR = Resolver
 SS = Sincos encoder

Jacket type (field N° 3)

A = PVC fixed installation
 B = PUR dynamic installation

Cable construction (field N° 4)

A = $[(2 \times 0,34) E (St) + 6 \times 2 \times 0,25 + 1 \times 2 \times 0,50] ST \text{ mm}^2$ (SI = Incremental encoder & EnDat)
 B = $[4 \times (2 \times 0,25) St] ST \text{ mm}^2$ (SR = Resolver)
 C = $[4 \times (2 \times 0,15) St + 1 \times 2 \times 0,50] ST \text{ mm}^2$ (SS = Sincos encoder)

Drive end connection (*) (field N° 5)

A = Unidrive M / Unidrive SP / Digitax ST (encoder 15 pin D type connector hd)
 B = Unidrive M / Unidrive SP resolver/sincos / Digitax ST (flying leads)
 P = Signal male plug
 S = Special

Motor end connection (field N° 6)

A = Unimotor 17 way no Speedtec connector
 B = Unimotor 12 way no Speedtec connector
 C = Unimotor 90° 17 way no Speedtec connector
 D = Unimotor 90° 12 way no Speedtec connector
 S = Special

Length metre (**) (field N° 7, 8, & 9 + 10)

0010 = 1 Metre
 0025 = 2.5 Metres
 1,000 = 100 Metres max
 5,000 = 500 Metres max cut end

Optional: Progressive alphanumeric code for custom special requests (field N° 11 & 12)

Note: (**) Length metre / cable requiring (cm) lengths will be rounded up to the next highest half metre; Eg. 2.1 will be charged as a 2.5 metre cable
 Maximum cable assembly length 100 meters

6.3.3 Signal Cable Construction

Application	Feedback	Drive end	Motor end	Code (xxxx = length)
Fixed	Incremental Encoder (ABZ + UVW) and/or SinCos EnDat	D type 15 pins	Flat	SI AAAAxxxx
			90°	SI AAACxxxx
		Flying leads	Flat	SI AABAxxxx
			90°	SI ABCxxxx
	Resolver	D type 15 pins	Flat	SR ABABxxxx
			90°	SR ABADxxxx
		Flying leads	Flat	SR BBBBxxxx
			90°	SR BBBDxxxx
	SinCos with Hiperface	D type 15 pins	Flat	SS ACABxxxx
			90°	SS ACADxxxx
		Flying leads	Flat	SS ACBBxxxx
			90°	SS ACBDxxxx
Dynamic	Incremental encoder (ABZ + UVW) and/or SinCos EnDat	D type 15 pins	Flat	SI BAAAxxxx
			90°	SI BAACxxxx
		Flying leads	Flat	SI BABAxxxx
			90°	SI BABCxxxx
	Resolver	D type 15 pins	Flat	SR BBABxxxx
			90°	SR BBADxxxx
		Flying leads	Flat	SR BBxxxxBB
			90°	SR BBBDxxxx
	SinCos with Hiperface	D type 15 pins	Flat	SS BCABxxxx
			90°	SS BCADxxxx
		Flying leads	Flat	SS BCBBxxxx
			90°	SS BCBDxxxx



6.4 Motor connector details

Power plug

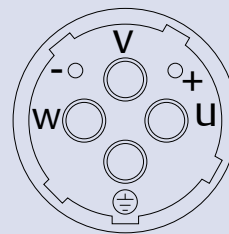
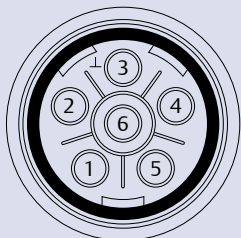

Size 1	With brake	Without brake	Size 1.5	With brake	Without brake
Pin	Function	Function	Pin	Function	Function
1	Phase U (R)	Phase U (R)	U	Phase U (R)	Phase U (R)
2	Phase V (S)	Phase V (S)	V	Phase V (S)	Phase V (S)
3	Ground	Ground	⊖	Ground	Ground
4	Phase W (T)	Phase W (T)	W	Phase W (T)	Phase W (T)
5	Brake		+	Brake	
6	Brake		-	Brake	
Shell	Screen	Screen	Shell	Screen	Screen

Signal plug

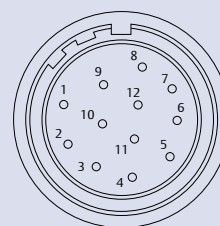
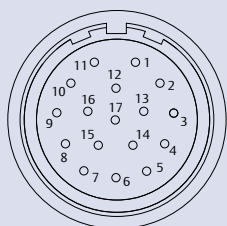

	Incremental encoder (CR, MR, CA, MA)	Heidenhain SinCos absolute encoders (EM, FM, EC, FC, EB, FB)	Resolver (AR, AE)	SICK Sin/Cos encoders (TL, UL, VF, WF, RA, SA)
Pin	Function	Function	Function	Function
1	Thermistor	Thermistor	Excitation High	REF Cos
2	Thermistor	Thermistor	Excitation Low	+ Data
3		Screen (Optical encoder only)	Cos High	- Data
4	S1		Cos Low	+ Cos
5	S1 Inverse		Sin High	+Sin
6	S2		Sin Low	REF Sin
7	S2 Inverse		Thermistor	Thermistor
8	S3	+ Clock	Thermistor	Thermistor
9	S3 Inverse	- Clock		Screen
10	Channel A	+ Cos		0 Volts
11	Index	+ Data		-
12	Index Inverse	- Data		+ V
13	Channel A Inverse	- Cos		
14	Channel B	+ Sin		
15	Channel B Inverse	- Sin		
16	+ V	+ V		
17	0 Volts	0 Volts		
Body	Screen	Screen		Screen

7 General Information

The manufacturer accepts no liability for any consequences resulting from inappropriate, negligent or incorrect installation or adjustment of the optional operating parameters of the equipment or from mismatching the variable speed drive with the motor.

The contents of this guide are believed to be correct at the time of printing. In the interests of a commitment to a policy of continuous development and improvement, the manufacturer reserves the right to change the specification of the product or its performance, or the contents of the guide, without notice.

All rights reserved. No parts of this guide may be reproduced or transmitted in any form or by any means, electrical or mechanical including photocopying, recording or by an information storage or retrieval system, without permission in writing from the publisher.

Control Techniques™

Leroy-Somer™

www.emersonindustrial.com/automation

Connect with us at:

twitter.com/ctandls

facebook.com/ctandls

youtube.com/c/controltechniquesandleroyssomer

theautomationengineer.com (blog)



© Emerson 2016. The information contained in this brochure is for guidance only and does not form part of any contract. The accuracy cannot be guaranteed as Emerson have an ongoing process of development and reserve the right to change the specification of their products without notice.

Emerson Industrial Automation Limited. Registered Office: The Gro, Newtown, Powys SY16 3BE. Registered in England and Wales. Company Reg. No. 01236886.

Moteurs Leroy-Somer SAS. Siège social: Bd Marcellin Leroy, CS 10015, 16915 Angoulême Cedex 9, France. Capital social: 656 800 512 €, RCS Angoulême 338 567 258.